

CE EMC Test Report

Report No.: CEBDBO-WTW-P21030355

Test Model: ECX-2200

Series Model: ECX-2200 Series, ECX-2XXXXXXXXXXXXXXXXXXXXXXXXXXXXX
("X" can be 0-9, A-Z or blank for marketing purpose)

Received Date: Mar. 10, 2021

Test Date: Mar. 15 to Apr. 13, 2021

Issued Date: Apr. 19, 2021

Applicant: Vecow Co., Ltd.

Address: 3F., No.10, Jiankang Rd., Zhonghe Dist., New Taipei City 23586, Taiwan

Issued By: Bureau Veritas Consumer Products Services (H.K.) Ltd., Taoyuan Branch
Lin Kou Laboratories

Lab Address: No. 47-2, 14th Ling, Chia Pau Vil., Lin Kou Dist., New Taipei City, Taiwan



This report is for your exclusive use. Any copying or replication of this report to or for any other person or entity, or use of our name or trademark, is permitted only with our prior written permission. This report sets forth our findings solely with respect to the test samples identified herein. The results set forth in this report are not indicative or representative of the quality or characteristics of the lot from which a test sample was taken or any similar or identical product unless specifically and expressly noted. Our report includes all of the tests requested by you and the results thereof based upon the information that you provided to us. You have 60 days from date of issuance of this report to notify us of any material error or omission caused by our negligence, provided, however, that such notice shall be in writing and shall specifically address the issue you wish to raise. A failure to raise such issue within the prescribed time shall constitute your unqualified acceptance of the completeness of this report, the tests conducted and the correctness of the report contents. Unless specific mention, the uncertainty of measurement has been explicitly taken into account to declare the compliance or non-compliance to the specification.

Table of Contents

Release Control Record	4
1 Certificate of Conformity	5
2 Summary of Test Results	6
2.1 Measurement Uncertainty	8
2.2 Modification Record.....	8
3 General Information	9
3.1 Description of EUT	9
3.2 Features of EUT	9
3.3 Operating Modes of EUT and Determination of Worst Case Operating Mode	10
3.4 Test Program Used and Operation Descriptions.....	11
3.5 Primary Clock Frequencies of Internal Source	11
4 Configuration and Connections with EUT	12
4.1 Connection Diagram of EUT and Peripheral Devices.....	12
4.2 Configuration of Peripheral Devices and Cable Connections.....	14
5 Conducted Emission from the AC Mains Power Port	16
5.1 Limits	16
5.2 Test Instruments	16
5.3 Test Arrangement	17
5.4 Test Results.....	18
6 Asymmetric Mode Conducted Emission at Telecommunication Ports	22
6.1 Limits	22
6.2 Test Instruments	23
6.3 Test Arrangement.....	24
6.4 Test Results	25
7 Radiated Emission at Frequencies up to 1GHz	27
7.1 Limits	27
7.2 Test Instruments	27
7.3 Test Arrangement.....	28
7.4 Test Results.....	29
8 Radiated Emission at Frequencies above 1GHz	31
8.1 Limits	31
8.2 Test Instruments	32
8.3 Test Arrangement.....	33
8.4 Test Results.....	34
9 Harmonics Current Measurement	36
9.1 Limits	36
9.2 Classification of Equipment.....	36
9.3 Test Instruments	36
9.4 Test Arrangement.....	37
9.5 Test Results.....	37
10 Voltage Fluctuations and Flicker Measurement	38
10.1 Limits	38
10.2 Test Instruments	38
10.3 Test Arrangement.....	38
10.4 Test Results.....	39
11 General Immunity Requirements	40

11.1	Performance Criteria	41
12	Electrostatic Discharge Immunity Test (ESD).....	42
12.1	Test Specification.....	42
12.2	Test Instruments	42
12.3	Test Arrangement.....	42
12.4	Test Results.....	44
13	Radiated, Radio-frequency, Electromagnetic Field Immunity Test (RS)	49
13.1	Test Specification.....	49
13.2	Test Instruments	49
13.3	Test Arrangement	50
13.4	Test Results.....	51
14	Electrical Fast Transient/Burst Immunity Test (EFT).....	52
14.1	Test Specification.....	52
14.2	Test Instruments	52
14.3	Test Arrangement	53
14.4	Test Results.....	54
15	Surge Immunity Test.....	55
15.1	Test Specification.....	55
15.2	Test Instruments	55
15.3	Test Arrangement	56
15.4	Test Results.....	57
16	Immunity to Conducted Disturbances Induced by RF Fields (CS).....	58
16.1	Test Specification.....	58
16.2	Test Instruments	59
16.3	Test Arrangement	60
16.4	Test Results.....	61
17	Power Frequency Magnetic Field Immunity Test.....	62
17.1	Test Specification.....	62
17.2	Test Instruments	62
17.3	Test Arrangement	62
17.4	Test Results.....	63
18	Voltage Dips and Interruptions	64
18.1	Test Specification.....	64
18.2	Test Instruments	64
18.3	Test Arrangement	64
18.4	Test Results.....	65
19	Pictures of Test Arrangements	66
19.1	Conducted Emission from the AC Mains Power Port.....	66
19.2	Asymmetric Mode Conducted Emission at Telecommunication Ports	67
19.3	Radiated Emission at Frequencies up to 1GHz	68
19.4	Radiated Emission at Frequencies above 1GHz	69
19.5	Harmonics Current, Voltage Fluctuations and Flicker Measurement.....	70
19.6	Electrostatic Discharge Immunity Test (ESD)	70
19.7	Radio-frequency, Electromagnetic Field Immunity Test (RS).....	71
19.8	Electrical Fast Transient/Burst Immunity Test (EFT)	72
19.9	Surge Immunity Test.....	74
19.10	Conducted Disturbances Induced by RF Fields (CS)	75
19.11	Power Frequency Magnetic Field Immunity Test (PFMF)	77
19.12	Voltage Dips and Interruptions	77
Appendix – Information of the Testing Laboratories		78

Release Control Record

Issue No.	Description	Date Issued
CEBDBO-WTW-P21030355	Original release.	Apr. 19, 2021

1 Certificate of Conformity

Product: Expandable Embedded Box PC

Brand: Vecow

Test Model: ECX-2200

Series Model: ECX-2200 Series, ECX-2XXXXXXXXXXXXXXXXXXXXXXXXXXXXX
("X" can be 0-9, A-Z or blank for marketing purpose)

Sample Status: Engineering sample

Applicant: Vecow Co., Ltd.

Test Date: Mar. 15 to Apr. 13, 2021

Standards: **EN 55032:2015 +A11:2020, Class A**
CISPR 32:2015+Cor1:2016, Class A
AS/NZS CISPR 32:2015, Class A
EN 61000-3-2:2014, Class D
EN 61000-3-3:2013
EN 55035:2017 +A11:2020

EN 61000-4-2:2009 / IEC 61000-4-2:2008 ED. 2.0

EN 61000-4-3:2006 +A1:2008 +A2:2010 / IEC 61000-4-3:2010 ED. 3.2

EN 61000-4-4:2012 / IEC 61000-4-4:2012 ED. 3.0

EN 61000-4-5:2014 +A1:2017 / IEC 61000-4-5:2014 +A1:2017 ED. 3.0

EN 61000-4-6:2014 +AC:2015 / IEC 61000-4-6:2013 ED. 4.0

EN 61000-4-8:2010 / IEC 61000-4-8:2009 ED. 2.0

EN 61000-4-11:2004 +A1:2017 / IEC 61000-4-11:2004 +A1:2017 ED. 2.0

Broadband impulse noise disturbances (Not applicable)

The above equipment has been tested by **Bureau Veritas Consumer Products Services (H.K.) Ltd., Taoyuan Branch**, and found compliance with the requirement of the above standards. The test record, data evaluation & Equipment Under Test (EUT) configurations represented herein are true and accurate accounts of the measurements of the sample's EMC characteristics under the conditions specified in this report.

Prepared by :  , **Date:** Apr. 19, 2021
Vivian Chen / Specialist

Approved by :  , **Date:** Apr. 19, 2021
Jim Hsiang / Associate Technical Manager

2 Summary of Test Results

Emission			
Standard	Test Item	Result/Remarks	Verdict
EN 55032:2015 +A11:2020 CISPR 32:2015+Cor1:2016	Conducted emission from the AC mains power port	Minimum passing Class A margin is -26.99 dB at 16.39665 MHz	Pass
	Asymmetric mode conducted emission at telecommunication ports	Minimum passing Class A margin is -14.17 dB at 1.19225 MHz	Pass
AS/NZS CISPR 32:2015	Radiated emission 30-1000 MHz	Minimum passing Class A margin is -5.32 dB at 216.01 MHz	Pass
	Radiated emission above 1GHz	Minimum passing Class A margin is -10.91 dB at 2310.00 MHz	Pass
EN 61000-3-2:2014	Harmonic current emissions	Class D	Pass
EN 61000-3-3:2013	Voltage fluctuations and flicker	$P_{st} \leq 1.0$ $d_{max} \leq 4\%$ $P_{lt} \leq 0.65$ $d_c \leq 3.3\%$ $T_{max} \leq 500ms$	Pass

Immunity				
EN 55035 Clause	Basic standard	Test Item	Result/Remarks	Verdict
4.2.1	EN 61000-4-2:2009 / IEC 61000-4-2:2008 ED. 2.0	Electrostatic Discharge (ESD)	Performance Criterion B	Pass
4.2.2.2	EN 61000-4-3:2006 +A1:2008 +A2:2010 / IEC 61000-4-3:2010 ED. 3.2	Continuous radiated disturbances (RS)	Performance Criterion A	Pass
4.2.4	EN 61000-4-4:2012 / IEC 61000-4-4:2012 ED. 3.0	Electrical fast transients (EFT)	Performance Criterion A	Pass
4.2.5	EN 61000-4-5:2014 +A1:2017 / IEC 61000-4-5:2014 +A1:2017 ED. 3.0	Surges	Performance Criterion A	Pass
4.2.2.3	EN 61000-4-6:2014 +AC:2015 / IEC 61000-4-6:2013 ED. 4.0	Continuous conducted disturbances (CS)	Performance Criterion A	Pass
4.2.3	EN 61000-4-8:2010 / IEC 61000-4-8:2009 ED. 2.0	Power-frequency magnetic fields (PFMF)	Performance Criterion A	Pass
4.2.6	EN 61000-4-11:2004 +A1:2017 / IEC 61000-4-11:2004 +A1:2017 ED. 2.0	Voltage dips and interruptions	Voltage Dips: <5% residual – 0.5 cycle, Performance Criterion A 70% residual – 25 cycles, Performance Criterion A Voltage Interruptions: <5% residual – 250 cycles, Performance Criterion C	Pass
4.2.7	-	Broadband impulse noise disturbances, Repetitive (Applicable only to xDSL ports.)	Without CPE xDSL port of the EUT.	N/A
4.2.7	-	Broadband impulse noise disturbances, Isolated (Applicable only to xDSL ports.)	Without CPE xDSL port of the EUT.	N/A

Note:

1. The above EN/IEC basic standards are applied with latest version if customer has no special requirement.
2. There is no deviation to the applied test methods and requirements covered by the scope of this report.
3. Determining compliance based on the results of the compliance measurement, not taking into account measurement instrumentation uncertainty.
4. N/A: Not Applicable

2.1 Measurement Uncertainty

Where relevant, the following measurement uncertainty levels have been estimated for tests performed on the EUT as specified in CISPR 16-4-2:

Measurement	Expanded Uncertainty (k=2) (\pm)	Maximum allowable uncertainty (\pm)
Conducted emission from AC mains power port using AMN, 150kHz ~ 30MHz	2.94 dB	3.4 dB (U_{CISPR})
Asymmetric mode conducted emission using AAN, 150kHz ~ 30MHz	3.88 dB	5.0 dB (U_{CISPR})
Radiated emission, 30MHz ~ 1GHz	4.30 dB	6.3 dB (U_{CISPR})
Radiated emission, 1GHz ~ 6GHz	4.96 dB	5.2 dB (U_{CISPR})

2.2 Modification Record

There were no modifications required for compliance.

3 General Information

3.1 Description of EUT

Product	Expandable Embedded Box PC
Brand	Vecow
Test Model	ECX-2200
Series Model	ECX-2200 Series, ECX-2XXXXXXXXXXXXXXXXXXXXXXXXXXXXXXXXXXXXX ("X" can be 0-9, A-Z or blank for marketing purpose)
Model Difference	For marketing purpose
Sample Status	Engineering sample
Operating Software	Windows 10, Burnintest
Power Supply Rating	DC from Adapter
Accessory Device	N/A
Data Cable Supplied	N/A

Note:

The EUT uses following adapter.

Brand	LITEON
Model	PA-1121-24
Input Power	100-240Vac, 2.0A, 50-60Hz
Output Power	24Vdc, 5A, 120W
Power Line	AC 3Pin Non-shielded DC cable (1.5m) with one ferrite core.

3.2 Features of EUT

1. The tests reported herein were performed according to the method specified by Vecow Co., Ltd., for detailed feature description, please refer to the manufacturer's specifications or user's manual.
2. The EUT was configured with the following key components:

Components	Brand	Model	Specification
CPU	Intel	i7-10700E	2.9GHz
RAM	innodisk	-	DDR4 2666 8GB
SSD	Innodisk	-	2.5" SATA SSD 3ME4 128GB

3.3 Operating Modes of EUT and Determination of Worst Case Operating Mode

- The EUT was pre-tested under operating and standby condition and the worst emission level was found under **operating condition**.
- The EUT consumed power from AC adapter, which designed with AC power supply of 100-240Vac, 50-60Hz.
For radiated emission evaluation, 230Vac/ 50Hz & 110Vac/ 60Hz had been covered during the pre-test.
The worst radiated emission data was found at **110Vac/ 60Hz** and recorded in the applied test report.
- EUT has been pre-tested under following test modes, and test **mode 1** was the worst case for final test.

Mode	Test Condition
1	Display* 2: 3840*2160, 60Hz + DVI: 1920*1080, 60Hz
2	Display* 2: 3840*2160, 60Hz + D-Sub: 1920*1080, 60Hz

- Test modes are presented in the report as below.

Mode	Test Condition	Input Power
Conducted emission test		
1	Display* 2: 3840*2160, 60Hz + DVI: 1920*1080, 60Hz	230Vac/ 50Hz & 110Vac/ 60Hz
Asymmetric mode conducted emission at telecommunication ports test		
1	Display* 2: 3840*2160, 60Hz + DVI: 1920*1080, 60Hz - LAN 1 port: Speed (1Gbps)	230Vac/ 50Hz
2	Display* 2: 3840*2160, 60Hz + DVI: 1920*1080, 60Hz - PoE LAN 6 port: Speed (100Mbps)	
The idle mode of conducted emission test at telecom port was pre-tested based on the worst case of link mode. Due to emissions of idle mode being very low compared to link mode, only the link mode data were presented in the test report.		
Radiated emission test		
1	Display* 2: 3840*2160, 60Hz + DVI: 1920*1080, 60Hz	110Vac/ 60Hz
Harmonics & Flicker and Immunity tests		
1	Display* 2: 3840*2160, 60Hz + DVI: 1920*1080, 60Hz	230Vac/ 50Hz

3.4 Test Program Used and Operation Descriptions

Emission tests (Harmonics & Flicker excluded):

- a. Turned on the power of all equipment.
- b. EUT ran a test program to enable all functions.
- c. EUT read and wrote messages from/to SSD, Micro SD card and ext. SSDs.
- d. EUT sent and received messages to/from Notebook PCs (kept in a remote area) via two UTP LAN cables (10m each).
- e. EUT sent “color bars with moving element” messages to ext. LCD Monitors. Then they displayed “color bars with moving elemen” messages on their screens simultaneously.
- f. EUT sent messages to printer and printer printed them out.
- g. EUT sent 1kHz audio signal to earphone.
- h. Set the EUT under full resistor load.
- i. IP cameras captured video image to LCD Monitors via EUT.
- j. Steps c-i were repeated.

Harmonics, Flicker, Immunity tests:

- a. Turned on the power of all equipment.
- b. EUT ran a test program to enable all functions.
- c. EUT read and wrote messages from/to SSD and ext. SSDs.
- d. EUT sent and received messages to/from Notebook PCs (kept in a remote area) via two UTP LAN cables (10m each).
- e. EUT sent “color bars” messages to ext. LCD Monitors. Then they displayed “color bars” messages on their screens simultaneously.
- f. EUT sent audio signal to earphone.
- g. Set the EUT under full resistor load.
- h. IP cameras captured video image to LCD Monitors via EUT.
- i. Steps c-h were repeated.

3.5 Primary Clock Frequencies of Internal Source

The highest frequency generated or used within the EUT or on which the EUT operates or tunes is 2.9GHz, provided by Vecow Co., Ltd., for detailed internal source, please refer to the manufacturer's specifications.

4 Configuration and Connections with EUT

4.1 Connection Diagram of EUT and Peripheral Devices

Emission tests (Harmonics & Flicker excluded):

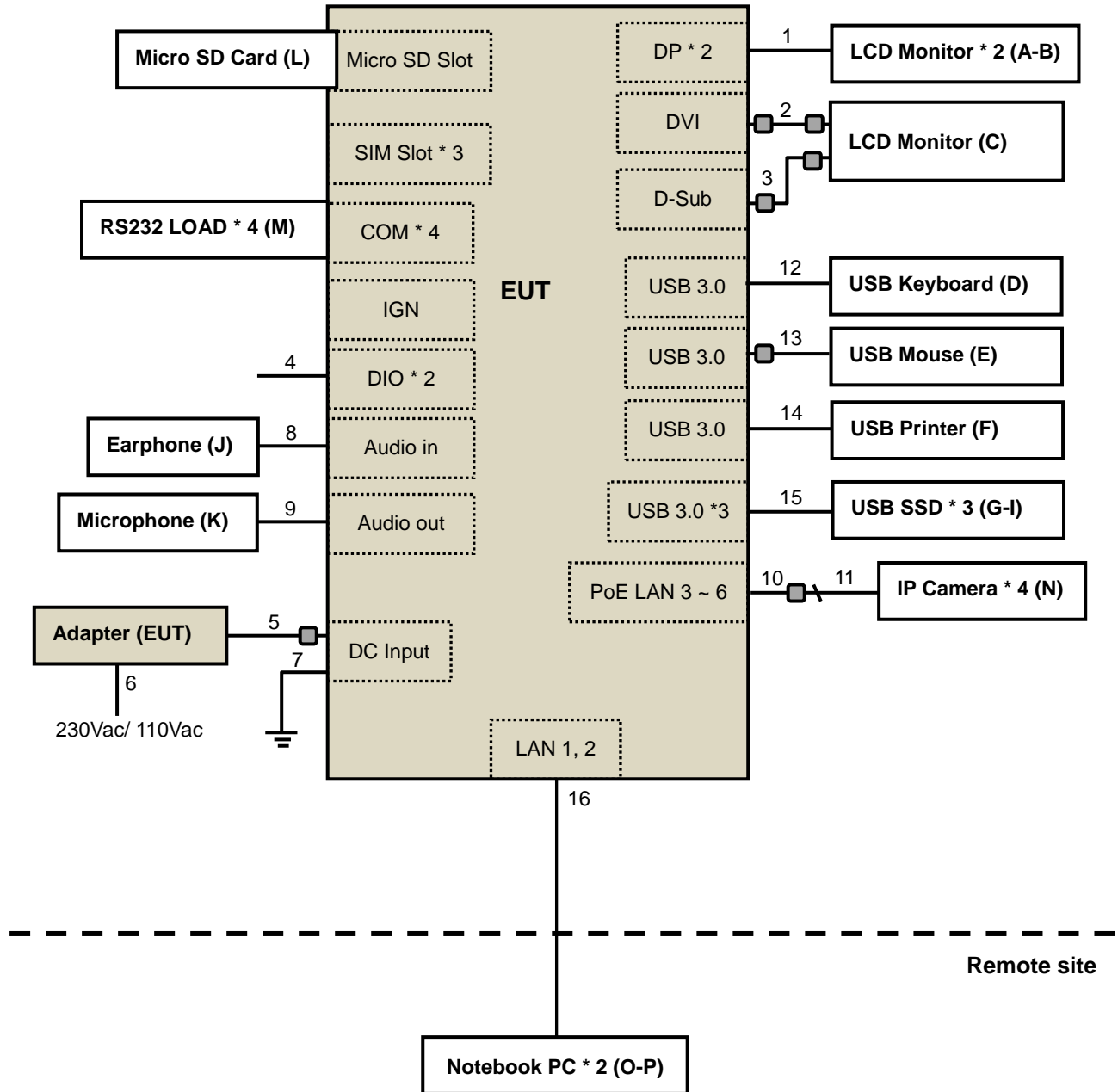

Harmonics & Flicker & Immunity tests:

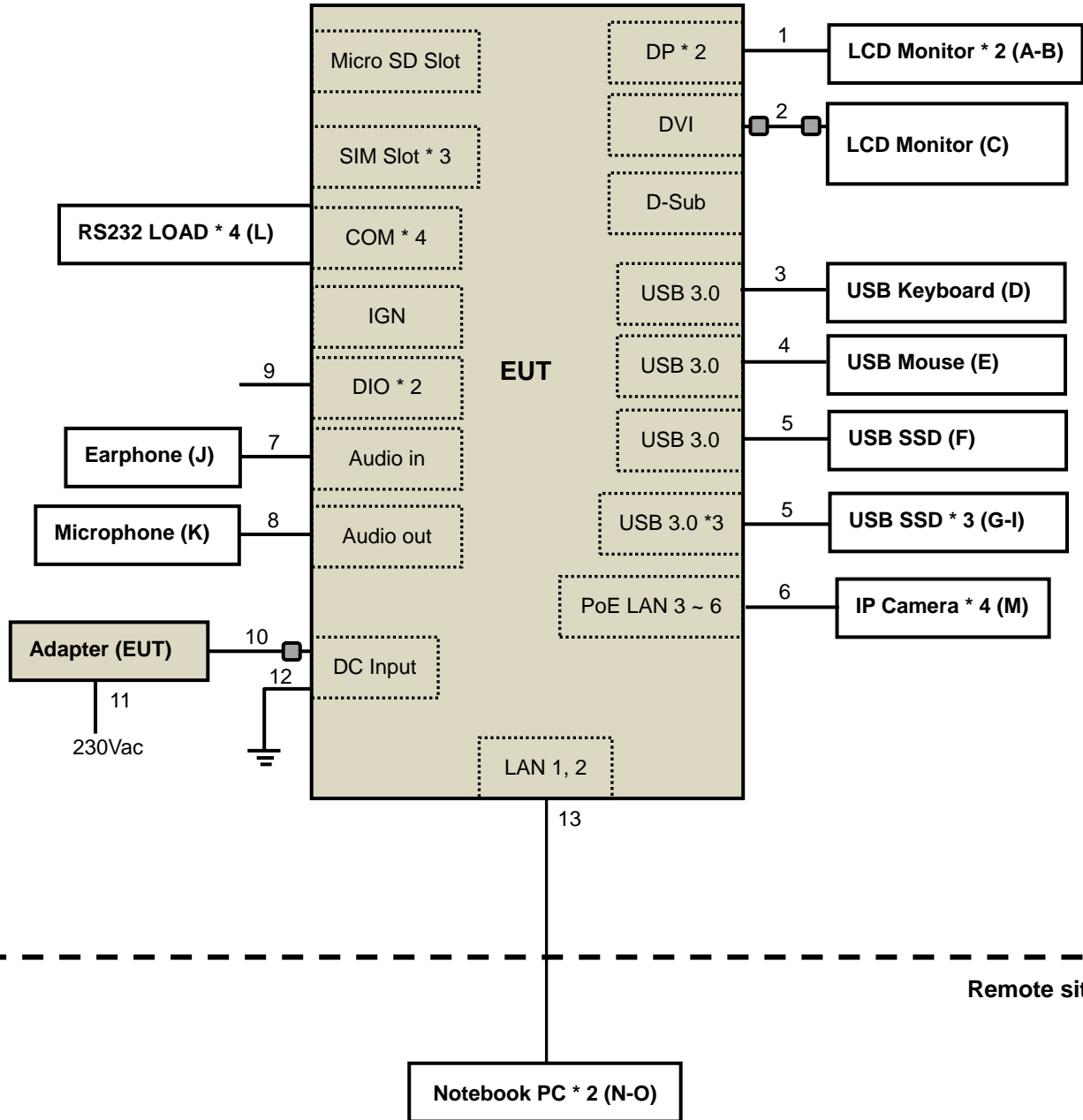

4.2 Configuration of Peripheral Devices and Cable Connections

Emission tests (Harmonics & Flicker excluded):

ID	Product	Brand	Model No.	Serial No.	FCC ID	Remarks
A.	LCD MONITOR	ASUS	VZ249	J3LMRS008938	NA	Provided by Lab
B.	LCD MONITOR	ASUS	MX27U	K1LMRS022990	NA	Provided by Lab
C.	LCD MONITOR	DELL	U2410	CN082WXD728720C C10NL	FCC DoC Approved	Provided by Lab
D.	USB Keyboard	Dell	KB216t	CN-0W33XP-LO300- 7CL-1909	NA	Provided by Lab
E.	USB Mouse	Microsoft	1113	9170528318308	FCC DoC Approved	Provided by Lab
F.	USB Printer	HP	HP Officejet Pro 251dw	CN55FCV012	FCC DoC Approved	Provided by Lab
G.	USB 3.1 SSD	WD	WDBK VX5120PS L	1922MD401387	NA	Supplied by client
H.	USB 3.1 SSD	WD	WDBK VX5120PS L	1922MD401254	NA	Provided by Lab
I.	USB 3.1 SSD	WD	WDBK VX5120PS L	1922MD400948	NA	Provided by Lab
J.	EARPHONE	PHILIPS	SBC HL145	N/A	NA	Provided by Lab
K.	MICROPHONE	Labtec	mic-333	N/A	NA	Provided by Lab
L.	Micro SD Card	SP	N/A	N/A	NA	Provided by Lab
M.	RS232 Load * 4	NA	NA	NA	NA	Supplied by client
N.	IP Camera * 4	NA	MBL030A-ORZ03 10	NA	NA	Supplied by client
O.	Notebook PC	SONY	SVS151A12P	275548477001024	NA	Provided by Lab
P.	Notebook PC	ASUS	PU401L	ECNXBC012528528	NA	Provided by Lab

Note:

1. All power cords of the above support units are non-shielded (1.8m).
2. Items O-P acted as communication partners to transfer data.

ID	Cable Descriptions	Qty.	Length (m)	Shielding (Yes/No)	Cores (Qty.)	Remarks
1.	DP cable	2	1.8	Y	0	Provided by Lab
2.	DVI cable	1	1.8	Y	2	Provided by Lab
3.	D-Sub cable	1	1.8	Y	2	Provided by Lab
4.	Signal cable	2	0.4	N	0	Provided by Lab
5.	DC power cable	1	1.5	N	1	Supplied by client
6.	AC power cable	1	1.8	N	0	Supplied by client
7.	GND cable	1	1.5	N	0	Provided by Lab
8.	Audio cable	1	1.2	N	0	Provided by Lab
9.	Audio cable	1	2.5	N	0	Provided by Lab
10.	LAN cable	4	0.2	N	4	Supplied by client (RJ45, Cat.5e)
11.	LAN cable	4	1.5	N	0	Provided by Lab (RJ45, Cat.5e)
12.	USB cable	1	1.8	Y	0	Provided by Lab
13.	USB cable	1	1.8	Y	1	Provided by Lab
14.	USB cable	1	1.8	Y	0	Provided by Lab
15.	USB cable	3	1.0	Y	0	Provided by Lab
16.	LAN cable	2	10	N	0	Provided by Lab (RJ45, Cat.5e)

Note: The core(s) is(are) originally attached to the cable(s).

Harmonics, Flicker, Immunity tests:

ID	Product	Brand	Model No.	Serial No.	FCC ID	Remarks
A.	LCD MONITOR	DELL	P2418HZM	CN-079XVV-TV200-8 AM-06AT	NA	Provided by Lab
B.	LCD MONITOR	Vita	VT-270JTG2	204270JTFE002	NA	Provided by Lab
C.	LCD MONITOR	Vita	VT-270JTG2	204270JTFE001	NA	Provided by Lab
D.	USB Keyboard	HP	KU-1516	NA	NA	Provided by Lab
E.	USB Mouse	Dell	MS111-P	NA	NA	Provided by Lab
F.	USB 3.1 SSD	WD	WDBK VX5120PS L	1922MD400824	FCC DoC Approved	Provided by Lab
G.	USB 3.1 SSD	WD	WDBK VX5120PS L	1922JG400125	NA	Supplied by client
H.	USB 3.1 SSD	WD	WDBK VX5120PS L	1922JG400129	NA	Provided by Lab
I.	USB 3.1 SSD	WD	WDBK VX5120PS L	1922MD401110	NA	Provided by Lab
J.	EARPHONE	N/A	NA	N/A	NA	Provided by Lab
K.	MICROPHONE	N/A	NA	N/A	NA	Provided by Lab
L.	RS232 Load * 4	NA	NA	NA	NA	Supplied by client
M.	IP Camera * 4	NA	MBL030A-ORZ03 10	NA	NA	Supplied by client
N.	Notebook PC	LENOVO	TP00057A	R9-0JMLFS16/01	NA	Provided by Lab
O.	Notebook PC	Lenovo	T470	PF-0QW0NQ	NA	Provided by Lab

Note:

1. All power cords of the above support units are non-shielded (1.8m).
2. Items N-O acted as communication partners to transfer data.

ID	Cable Descriptions	Qty.	Length (m)	Shielding (Yes/No)	Cores (Qty.)	Remarks
1.	DP cable	2	1.8	Y	0	Provided by Lab
2.	DVI cable	1	1.8	Y	2	Provided by Lab
3.	USB cable	1	1.8	Y	0	Provided by Lab
4.	USB cable	1	1.8	Y	0	Provided by Lab
5.	USB cable	4	0.3	Y	0	Provided by Lab
6.	LAN cable	4	3.0	N	0	Provided by Lab (RJ45, Cat.5e)
7.	Audio cable	1	1.0	N	0	Provided by Lab
8.	Audio cable	1	1.0	N	0	Provided by Lab
9.	Signal cable	2	0.4	N	0	Supplied by client
10.	DC power cable	1	1.5	N	1	Supplied by client
11.	AC power cable	1	1.8	N	0	Supplied by client
12.	GND cable	1	3.0	N	0	Provided by Lab
13.	LAN cable	2	3.0	N	0	Provided by Lab (RJ45, Cat.5e)

Note: The core(s) is(are) originally attached to the cable(s).

5 Conducted Emission from the AC Mains Power Port

5.1 Limits

Class A			
Frequency range (MHz)	Coupling device	Detector type / bandwidth	Limits (dBuV)
0.15 - 0.5	AMN	Quasi-peak / 9kHz	79
0.5 - 30.0			73
0.15 - 0.5		Average / 9kHz	66
0.5 - 30.0			60
Class B			
Frequency range (MHz)	Coupling device	Detector type / bandwidth	Limits (dBuV)
0.15 - 0.5	AMN	Quasi-peak / 9kHz	66 - 56
0.5 - 5			56
5 - 30.0			60
0.15 - 0.5		Average / 9kHz	56 - 46
0.5 - 5			46
5 - 30.0			50

- Notes: 1. The lower limit shall apply at the transition frequencies.
 2. The limit decreases linearly with the logarithm of the frequency in the range of 0.15 to 0.50 MHz.

5.2 Test Instruments

Description & Manufacturer	Model No.	Serial No.	Cal. Date	Cal. Due
ROHDE & SCHWARZ TEST RECEIVER	ESR3	102413	Feb. 8, 2021	Feb. 7, 2022
ROHDE & SCHWARZ Artificial Mains Network (for EUT)	ESH2-Z5	100104	Dec. 18, 2020	Dec. 17, 2021
LISN With Adapter (for EUT)	AD10	C09Ada-001	Dec. 8, 2020	Dec. 7, 2021
ROHDE & SCHWARZ Artificial Mains Network (for peripherals)	ESH3-Z5	847265/023	Nov. 11, 2020	Nov. 10, 2021
SCHWARZBECK Artificial Mains Network (For EUT)	NNLK8129	8129229	May 14, 2020	May 13, 2021
SCHWARZBECK Artificial Mains Network (for EUT)	NNLK 8121	8121-808	Apr. 10, 2020	Apr. 9, 2021
Software	Cond_V7.3.7.4	NA	NA	NA
RF cable (JYEBAO) With 10dB PAD	5D-FB	Cable-C09.01	Aug. 14, 2020	Aug. 13, 2021
LYNICS Terminator (For ROHDE & SCHWARZ LISN)	0900510	E1-01-299	Jan. 27, 2021	Jan. 26, 2022

- Note: 1. The calibration interval of the above test instruments is 12 months and the calibrations are traceable to NML/ROC and NIST/USA.
 2. The test was performed in Shielded Room No. 9. (Conduction 9)
 3. The VCCI Site Registration No. C-11312.
 4. Tested Date: Mar. 15, 2021

5.3 Test Arrangement

- The EUT was placed 0.4 meters from the conducting wall of the shielded room with EUT being connected to the power mains through an Artificial Mains Network (AMN). Other support units were connected to the power mains through another AMN. The two AMNs provide 50 Ohm/ 50uH of coupling impedance for the measuring instrument.
- Both lines of the power mains connected to the EUT were checked for maximum conducted interference.
- The test results of conducted emissions at mains ports are recorded of six worst margins for quasi-peak (mandatory) [and average (if necessary)] values against the limits at frequencies of interest unless the margin is 20 dB or greater.

Note: The resolution bandwidth and video bandwidth of test receiver is 9kHz for quasi-peak detection (QP) and average detection (AV) at frequency 0.15MHz-30MHz.

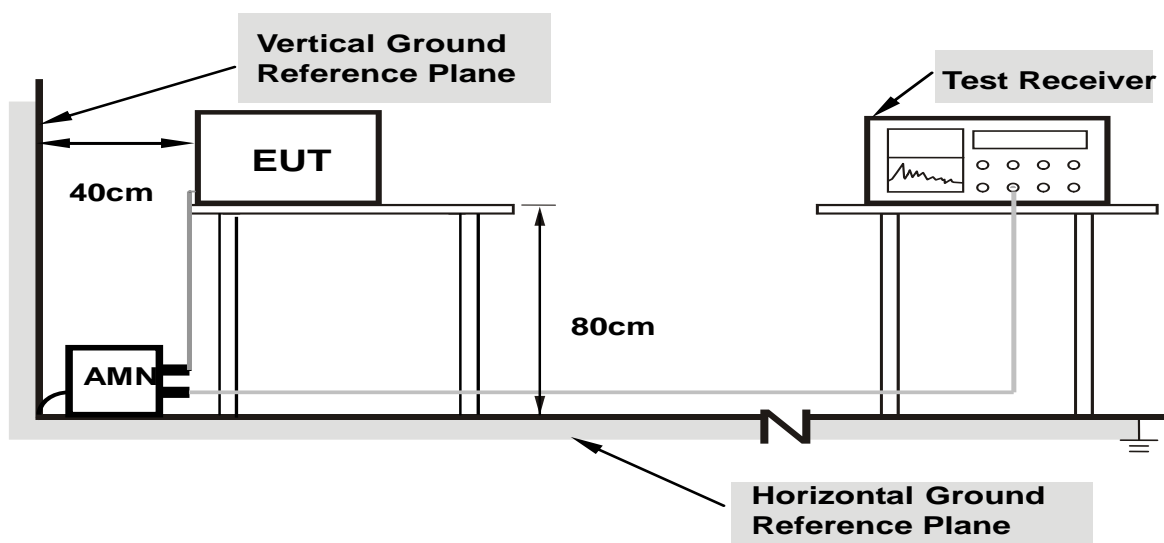

- Note:**
- Support units were connected to second AMN.
 - The distance specified between EUT/AE and other metallic objects is ≥ 0.8 m in the measurement arrangement for table-top EUT.
 - Cable on the RGP must to be insulated.

For the actual test configuration, please refer to the related item – Photographs of the Test Configuration.

5.4 Test Results

Frequency Range	150kHz ~ 30MHz	Detector Function & Resolution Bandwidth	Quasi-Peak (QP) / Average (AV), 9kHz
Input Power	110Vac, 60Hz	Environmental Conditions	21°C, 65%RH, 1004mbar
Tested by	Vhenson Huang	Test Date	2021/3/15
Test Mode	Mode 1		

Phase Of Power : Line (L)										
No	Frequency (MHz)	Correction Factor (dB)	Reading Value (dBuV)		Emission Level (dBuV)		Limit (dBuV)		Margin (dB)	
			Q.P.	AV.	Q.P.	AV.	Q.P.	AV.	Q.P.	AV.
1	0.15719	10.20	21.60	3.66	31.80	13.86	79.00	66.00	-47.20	-52.14
2	0.41890	10.22	27.44	12.21	37.66	22.43	79.00	66.00	-41.34	-43.57
3	0.63688	10.24	27.77	19.17	38.01	29.41	73.00	60.00	-34.99	-30.59
4	0.96541	10.28	28.10	15.34	38.38	25.62	73.00	60.00	-34.62	-34.38
5	5.79393	10.55	26.67	19.44	37.22	29.99	73.00	60.00	-35.78	-30.01
6	7.34660	10.62	27.67	18.45	38.29	29.07	73.00	60.00	-34.71	-30.93
7	16.39665	11.01	31.13	22.00	42.14	33.01	73.00	60.00	-30.86	-26.99

Remarks:

1. Q.P. and AV. are abbreviations of quasi-peak and average individually.
2. The emission levels of other frequencies were very low against the limit.
3. Margin value = Emission level – Limit value
4. Correction factor = Insertion loss + Cable loss
5. Emission Level = Correction Factor + Reading Value

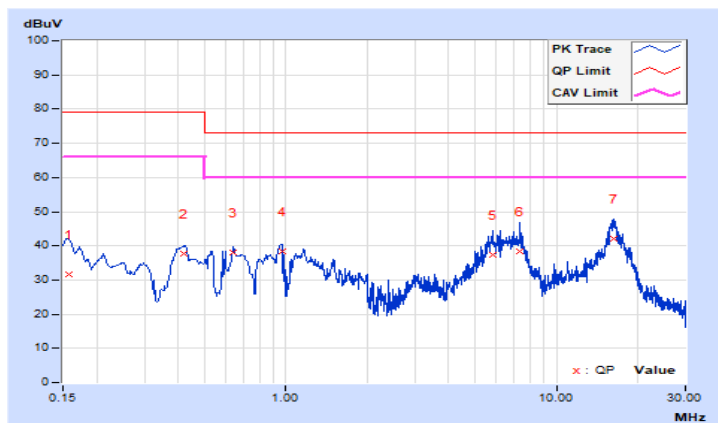

Frequency Range	150kHz ~ 30MHz	Detector Function & Resolution Bandwidth	Quasi-Peak (QP) / Average (AV), 9kHz
Input Power	110Vac, 60Hz	Environmental Conditions	21°C, 65%RH, 1004mbar
Tested by	Vhenson Huang	Test Date	2021/3/15
Test Mode	Mode 1		

Phase Of Power : Neutral (N)										
No	Frequency (MHz)	Correction Factor (dB)	Reading Value (dBuV)		Emission Level (dBuV)		Limit (dBuV)		Margin (dB)	
			Q.P.	AV.	Q.P.	AV.	Q.P.	AV.	Q.P.	AV.
1	0.21258	10.21	28.69	20.38	38.90	30.59	79.00	66.00	-40.10	-35.41
2	0.64024	10.26	26.83	19.61	37.09	29.87	73.00	60.00	-35.91	-30.13
3	0.96541	10.28	26.97	14.80	37.25	25.08	73.00	60.00	-35.75	-34.92
4	5.94646	10.55	27.11	20.28	37.66	30.83	73.00	60.00	-35.34	-29.17
5	7.11576	10.60	28.40	19.57	39.00	30.17	73.00	60.00	-34.00	-29.83
6	16.30279	10.87	22.36	13.90	33.23	24.77	73.00	60.00	-39.77	-35.23

Remarks:

1. Q.P. and AV. are abbreviations of quasi-peak and average individually.
2. The emission levels of other frequencies were very low against the limit.
3. Margin value = Emission level – Limit value
4. Correction factor = Insertion loss + Cable loss
5. Emission Level = Correction Factor + Reading Value

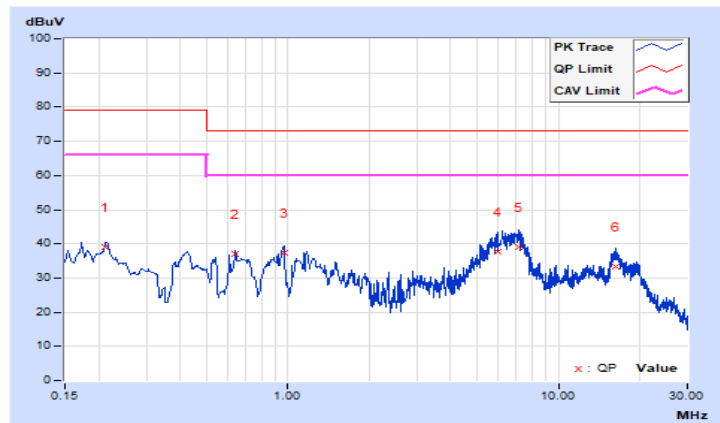

Frequency Range	150kHz ~ 30MHz	Detector Function & Resolution Bandwidth	Quasi-Peak (QP) / Average (AV), 9kHz
Input Power	230Vac, 50Hz	Environmental Conditions	21°C, 65%RH, 1004mbar
Tested by	Vhenson Huang	Test Date	2021/3/15
Test Mode	Mode 1		

Phase Of Power : Line (L)										
No	Frequency (MHz)	Correction Factor (dB)	Reading Value (dBuV)		Emission Level (dBuV)		Limit (dBuV)		Margin (dB)	
			Q.P.	AV.	Q.P.	AV.	Q.P.	AV.	Q.P.	AV.
1	0.22731	10.20	21.52	11.17	31.72	21.37	79.00	66.00	-47.28	-44.63
2	0.56258	10.24	29.79	8.51	40.03	18.75	73.00	60.00	-32.97	-41.25
3	0.72656	10.25	28.63	8.62	38.88	18.87	73.00	60.00	-34.12	-41.13
4	0.91375	10.27	26.87	7.22	37.14	17.49	73.00	60.00	-35.86	-42.51
5	7.20972	10.61	26.25	18.94	36.86	29.55	73.00	60.00	-36.14	-30.45
6	16.32626	11.01	26.32	19.01	37.33	30.02	73.00	60.00	-35.67	-29.98

Remarks:

1. Q.P. and AV. are abbreviations of quasi-peak and average individually.
2. The emission levels of other frequencies were very low against the limit.
3. Margin value = Emission level – Limit value
4. Correction factor = Insertion loss + Cable loss
5. Emission Level = Correction Factor + Reading Value

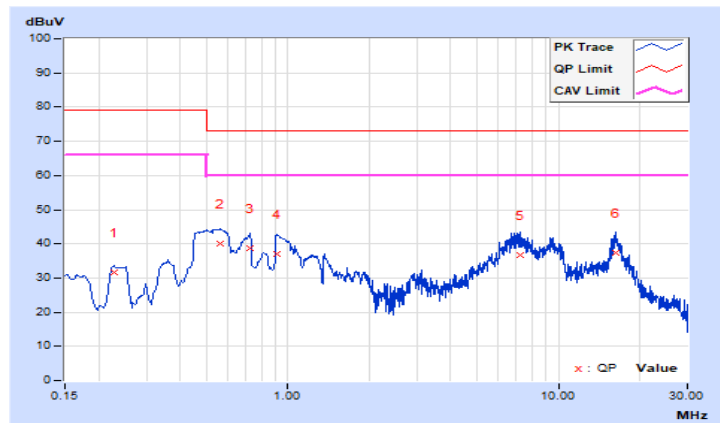

Frequency Range	150kHz ~ 30MHz	Detector Function & Resolution Bandwidth	Quasi-Peak (QP) / Average (AV), 9kHz
Input Power	230Vac, 50Hz	Environmental Conditions	21°C, 65%RH, 1004mbar
Tested by	Vhenson Huang	Test Date	2021/3/15
Test Mode	Mode 1		

Phase Of Power : Neutral (N)										
No	Frequency (MHz)	Correction Factor (dB)	Reading Value (dBuV)		Emission Level (dBuV)		Limit (dBuV)		Margin (dB)	
			Q.P.	AV.	Q.P.	AV.	Q.P.	AV.	Q.P.	AV.
1	0.22972	10.21	22.37	9.46	32.58	19.67	79.00	66.00	-46.42	-46.33
2	0.55680	10.25	27.42	6.22	37.67	16.47	73.00	60.00	-35.33	-43.53
3	0.88719	10.27	23.57	6.69	33.84	16.96	73.00	60.00	-39.16	-43.04
4	6.92421	10.59	28.32	21.39	38.91	31.98	73.00	60.00	-34.09	-28.02
5	9.54849	10.69	26.34	17.50	37.03	28.19	73.00	60.00	-35.97	-31.81
6	16.75256	10.88	21.65	11.65	32.53	22.53	73.00	60.00	-40.47	-37.47

Remarks:

1. Q.P. and AV. are abbreviations of quasi-peak and average individually.
2. The emission levels of other frequencies were very low against the limit.
3. Margin value = Emission level – Limit value
4. Correction factor = Insertion loss + Cable loss
5. Emission Level = Correction Factor + Reading Value

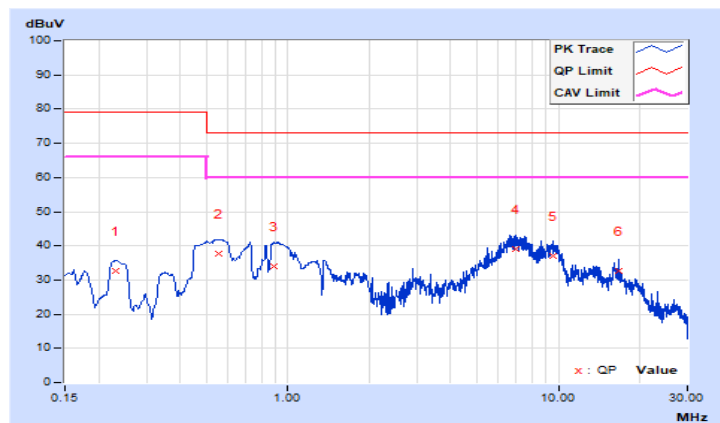

6 Asymmetric Mode Conducted Emission at Telecommunication Ports

6.1 Limits

Class A					
Frequency range (MHz)	Coupling device	Detector type / bandwidth	Voltage limits (dBuV)	Current limits (dBuA)	
0.15 - 0.5	AAN	Quasi-peak / 9kHz	97 – 87	N/A	
0.5 - 30.0			87		
0.15 - 0.5	AAN	Average / 9kHz	84-74		
0.5 - 30.0			74		
0.15 - 0.5	CVP and current probe	Quasi-peak / 9kHz	97 – 87		53 – 43
0.5 - 30.0			87		43
0.15 - 0.5	CVP and current probe	Average / 9kHz	84-74	40 – 30	
0.5 - 30.0			74	30	
0.15 - 0.5	Current Probe	Quasi-peak / 9kHz	N/A	53 – 43	
0.5 - 30.0				43	
0.15 - 0.5	Current Probe	Average / 9kHz		40 – 30	
0.5 - 30.0				30	
Class B					
Frequency range (MHz)	Coupling device	Detector type / bandwidth	Voltage limits (dBuV)	Current limits (dBuA)	
0.15 - 0.5	AAN	Quasi-peak / 9kHz	84 – 74	N/A	
0.5 - 30.0			74		
0.15 - 0.5	AAN	Average / 9kHz	74-64		
0.5 - 30.0			64		
0.15 - 0.5	CVP and current probe	Quasi-peak / 9kHz	84 – 74	40 – 30	
0.5 - 30.0			74	30	
0.15 - 0.5	CVP and current probe	Average / 9kHz	74-64	30 – 20	
0.5 - 30.0			64	20	
0.15 - 0.5	Current Probe	Quasi-peak / 9kHz	N/A	40 – 30	
0.5 - 30.0				30	
0.15 - 0.5	Current Probe	Average / 9kHz		30 – 20	
0.5 - 30.0				20	

Notes: 1. The lower limit shall apply at the transition frequencies.

2. The limit decreases linearly with the logarithm of the frequency in the range of 0.15 to 0.50 MHz.

6.2 Test Instruments

Description & Manufacturer	Model No.	Serial No.	Cal. Date	Cal. Due
ROHDE & SCHWARZ TEST RECEIVER	ESR3	102413	Feb. 8, 2021	Feb. 7, 2022
ROHDE & SCHWARZ Artificial Mains Network (for EUT)	ESH2-Z5	100104	Dec. 18, 2020	Dec. 17, 2021
LISN With Adapter (for EUT)	AD10	C09Ada-001	Dec. 8, 2020	Dec. 7, 2021
ROHDE & SCHWARZ Artificial Mains Network (for peripherals)	ESH3-Z5	847265/023	Nov. 11, 2020	Nov. 10, 2021
SCHWARZBECK Artificial Mains Network (For EUT)	NNLK8129	8129229	May 14, 2020	May 13, 2021
SCHWARZBECK Artificial Mains Network (for EUT)	NNLK 8121	8121-808	Apr. 10, 2020	Apr. 9, 2021
Software	Cond_V7.3.7.4	NA	NA	NA
Software	ISN_V7.3.7.4	NA	NA	NA
RF cable (JYEBAO)	5D-FB	Cable-C09.01	Aug. 14, 2020	Aug. 13, 2021
SUHNER Terminator (For ROHDE & SCHWARZ LISN)	0900510	E1-01-299	Jan. 27, 2021	Jan. 26, 2022
FCC ISN	F-071115-1057-1	20650	Feb. 3, 2021	Feb. 2, 2022

- Note: 1. The calibration interval of the above test instruments is 12 months and the calibrations are traceable to NML/ROC and NIST/USA.
2. The test was performed in Shielded Room No. 9. (ISN 9)
3. The VCCI Site Registration No. T-11587
4. Tested Date: Mar. 15, 2021

6.3 Test Arrangement

Method of Using AANs:

- The EUT is placed 0.4 meters from the conducting wall of the shielded room and connected to AAN directly to reference ground plane.
- If voltage measurement is used, measure voltage at the measurement port of the AAN, correct the reading by adding the AAN voltage division factor, and compare to the voltage limit.
- It is not necessary to apply the voltage and the current limit if a AAN is used.
- The test results of disturbance at telecommunication ports are recorded of six worst margins for quasi-peak (mandatory) [and average (if necessary)] values against the limits at frequencies of interest unless the margin is 20 dB or greater.

Note: The resolution bandwidth and video bandwidth of test receiver is 9kHz for quasi-peak detection (QP) and average detection (AV) at frequency 0.15MHz-30MHz.

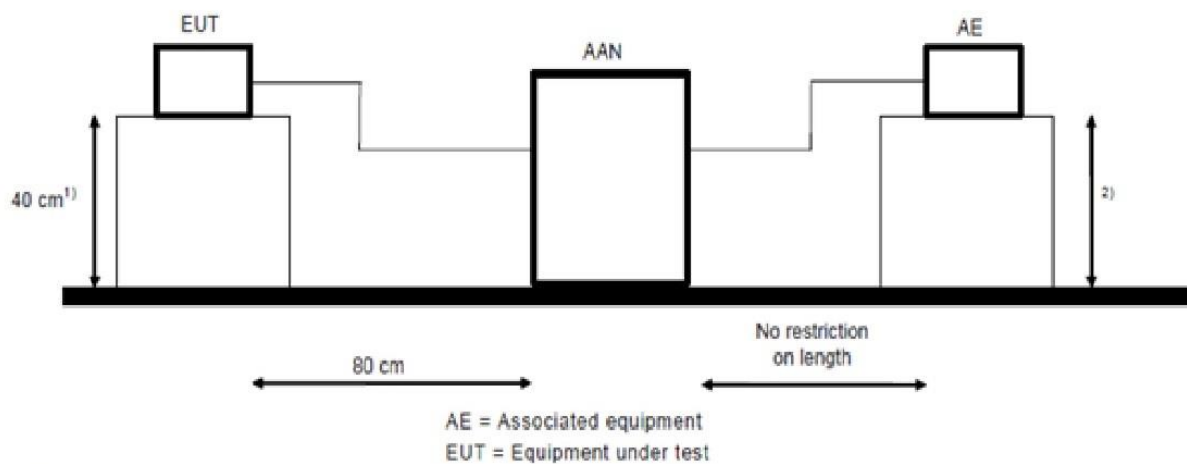

1) Distance to the reference groundplane (vertical or horizontal).

2) Distance to the reference groundplane is not critical.

Note: Cable on the RGP must be insulated.

For the actual test configuration, please refer to the related item – Photographs of the Test Configuration.

6.4 Test Results

Frequency Range	150kHz ~ 30MHz	Detector Function & Resolution Bandwidth	Quasi-Peak (QP) / Average (AV), 9kHz
Input Power	230Vac, 50Hz	Environmental Conditions	21°C, 65%RH, 1004mbar
Tested by	Vhenson Huang	Test Date	2021/3/15
Test Mode	Mode 1 RJ45 TELECOM PORT (1Gbps, TFGEN+PING)		

No	Frequency (MHz)	Correction Factor (dB)	Reading Value (dBuV)		Emission Level (dBuV)		Limit (dBuV)		Margin (dB)	
			Q.P.	AV.	Q.P.	AV.	Q.P.	AV.	Q.P.	AV.
1	0.50242	9.53	42.44	38.35	51.97	47.88	87.00	74.00	-35.03	-26.12
2	0.59777	9.49	44.47	42.15	53.96	51.64	87.00	74.00	-33.04	-22.36
3	1.79063	9.33	43.62	42.57	52.95	51.90	87.00	74.00	-34.05	-22.10
4	2.82131	9.30	43.63	30.17	52.93	39.47	87.00	74.00	-34.07	-34.53
5	10.27594	9.45	40.30	30.70	49.75	40.15	87.00	74.00	-37.25	-33.85
6	21.24629	9.98	38.51	32.74	48.49	42.72	87.00	74.00	-38.51	-31.28

Remarks:

1. Q.P. and AV. are abbreviations of quasi-peak and average individually.
2. The emission levels of other frequencies were very low against the limit.
3. Margin value = Emission level – Limit value
4. Correction factor = Insertion loss + Cable loss
5. Emission Level = Correction Factor + Reading Value

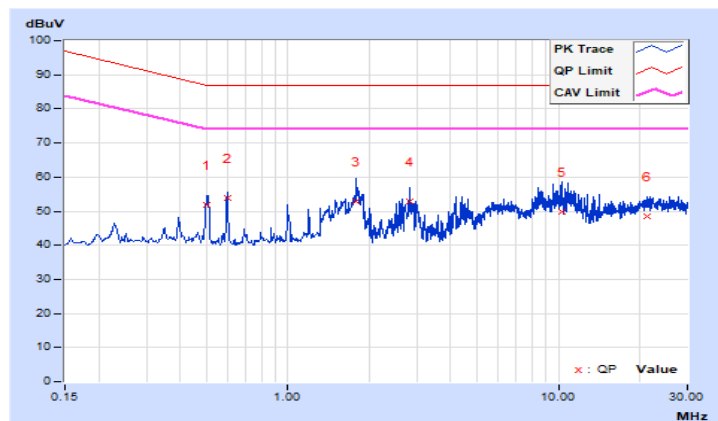

Frequency Range	150kHz ~ 30MHz	Detector Function & Resolution Bandwidth	Quasi-Peak (QP) / Average (AV), 9kHz
Input Power	230Vac, 50Hz	Environmental Conditions	21°C, 65%RH, 1004mbar
Tested by	Vhenson Huang	Test Date	2021/3/15
Test Mode	Mode 2 RJ45 TELECOM PORT (100Mbps, TFGEN+PING)		

No	Frequency (MHz)	Correction Factor (dB)	Reading Value (dBuV)		Emission Level (dBuV)		Limit (dBuV)		Margin (dB)	
			Q.P.	AV.	Q.P.	AV.	Q.P.	AV.	Q.P.	AV.
1	0.23022	9.75	49.70	47.51	59.45	57.26	93.44	80.44	-33.99	-23.18
2	0.39639	9.59	50.91	50.91	60.50	60.50	88.93	75.93	-28.43	-15.43
3	1.19225	9.38	50.63	50.45	60.01	59.83	87.00	74.00	-26.99	-14.17
4	14.03050	9.62	47.96	43.69	57.58	53.31	87.00	74.00	-29.42	-20.69
5	16.22848	9.73	52.02	48.92	61.75	58.65	87.00	74.00	-25.25	-15.35
6	23.13140	10.09	50.97	48.25	61.06	58.34	87.00	74.00	-25.94	-15.66

Remarks:

1. Q.P. and AV. are abbreviations of quasi-peak and average individually.
2. The emission levels of other frequencies were very low against the limit.
3. Margin value = Emission level – Limit value
4. Correction factor = Insertion loss + Cable loss
5. Emission Level = Correction Factor + Reading Value

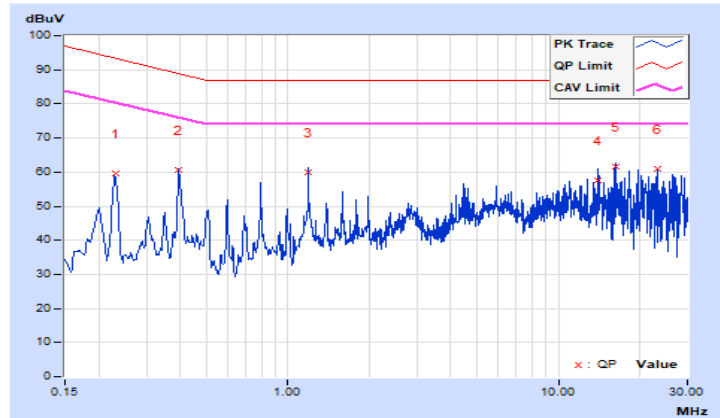

7 Radiated Emission at Frequencies up to 1GHz

7.1 Limits

Class A		
Frequency range (MHz)	Distance (m)	Limits (dBuV/m)
30 - 230	10	40
230 - 1000		47
30 - 230	3	50
230 - 1000		57
Class B		
Frequency range (MHz)	Distance (m)	Limits (dBuV/m)
30 - 230	10	30
230 - 1000		37
30 - 230	3	40
230 - 1000		47

Note: The lower limit shall apply at the transition frequencies.

7.2 Test Instruments

Description & Manufacturer	Model No.	Serial No.	Cal. Date	Cal. Due
ROHDE & SCHWARZ TEST RECEIVER	ESCS 30	100027	May 19, 2020	May 18, 2021
Schwarzbeck Bilog Antenna	VULB9168	9168-303	Nov. 5, 2020	Nov. 4, 2021
Agilent Preamplifier	8447D	2944A08119	Feb. 18, 2021	Feb. 17, 2022
ADT. Turn Table	TT100	0205	NA	NA
ADT. Tower	AT100	0205	NA	NA
Software	Radiated_V7.6.15.9.5	NA	NA	NA
ADT RF Switches BOX	EMH-011	1001	Oct. 23, 2020	Oct. 22, 2021
Pacific RF cable With 5dB PAD	8D	CABLE-ST2-01	Oct. 23, 2020	Oct. 22, 2021

Note: 1. The calibration interval of the above test instruments is 12 months and the calibrations are traceable to NML/ROC and NIST/USA.
 2. The test was performed in Open Site No. 2.
 3. The VCCI Site Registration No. R-10237.
 4. Tested Date: Mar. 19, 2021

7.3 Test Arrangement

- The EUT was placed on the top of a rotating table 0.8 meters above the ground at an accredited test facility. The table was rotated 360 degrees to determine the position of the highest radiation.
- The EUT was set 10 meters away from the interference-receiving antenna, which was mounted on the top of a variable-height antenna tower.
- The antenna is a broadband antenna, and its height is varied from one meter to four meters above the ground to determine the maximum value of the field strength. Both horizontal and vertical polarizations of the antenna are set to make the measurement.
- For each suspected emission, the EUT was arranged to its worst case and then the antenna was tuned to heights from 1 meter to 4 meters and the rotatable table was turned from 0 degrees to 360 degrees to find the maximum reading.
- The test-receiver system was set to quasi-peak detect function and specified bandwidth with maximum hold mode when the test frequency is up to 1 GHz.

Note:

- The resolution bandwidth and video bandwidth of test receiver/spectrum analyzer is 120kHz for quasi-peak detection (QP) at frequency up to 1GHz.
- The measurement distance is the shortest horizontal distance between an imaginary circular periphery just encompassing this arrangement and the calibration point of the antenna.

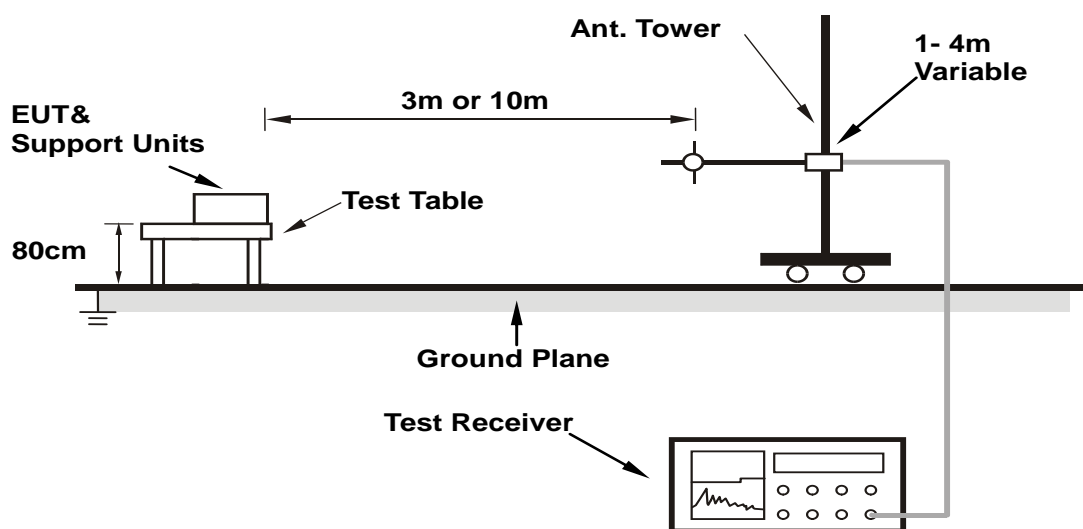

Note: Cable on the RGP must be insulated.

For the actual test configuration, please refer to the related item – Photographs of the Test Configuration.

7.4 Test Results

Frequency Range	30MHz ~ 1GHz	Detector Function & Resolution Bandwidth	Quasi-Peak (QP), 120kHz
Tested By	Paul Chen	Environmental Conditions	21.0°C, 73.0%RH, 1006mbar
Test Mode	Mode 1	Test Date	2021/3/19

Antenna Polarity & Test Distance : Horizontal at 10 m								
No	Frequency (MHz)	Emission Level (dBuV/m)	Limit (dBuV/m)	Margin (dB)	Antenna Height (m)	Table Angle (Degree)	Raw Value (dBuV)	Correction Factor (dB/m)
1	82.59	27.96 QP	40.00	-12.04	4.00 H	288	43.40	-15.44
2	125.01	29.13 QP	40.00	-10.87	4.00 H	122	40.32	-11.19
3	136.69	30.25 QP	40.00	-9.75	4.00 H	94	40.24	-9.99
4	189.02	32.93 QP	40.00	-7.07	4.00 H	278	44.81	-11.88
5	216.01	34.68 QP	40.00	-5.32	4.00 H	250	46.64	-11.96
6	297.02	32.84 QP	47.00	-14.16	3.76 H	163	40.73	-7.89
7	324.08	37.93 QP	47.00	-9.07	3.42 H	174	44.92	-6.99
8	462.01	34.15 QP	47.00	-12.85	2.13 H	99	38.31	-4.16
9	499.99	38.71 QP	47.00	-8.29	1.89 H	241	42.19	-3.48
10	550.02	37.96 QP	47.00	-9.04	1.75 H	239	40.54	-2.58
11	599.99	36.12 QP	47.00	-10.88	1.37 H	288	37.24	-1.12
12	924.00	39.31 QP	47.00	-7.69	1.00 H	177	33.59	5.72
13	960.00	35.19 QP	47.00	-11.81	1.00 H	97	28.92	6.27

Remarks:

1. Emission Level(dBuV/m) = Raw Value(dBuV) + Correction Factor(dB/m)
2. Correction Factor(dB/m) = Antenna Factor (dB/m) + Cable Factor (dB) – Pre-Amplifier Factor (dB)
3. The other emission levels were very low against the limit.
4. Margin value = Emission level – Limit value

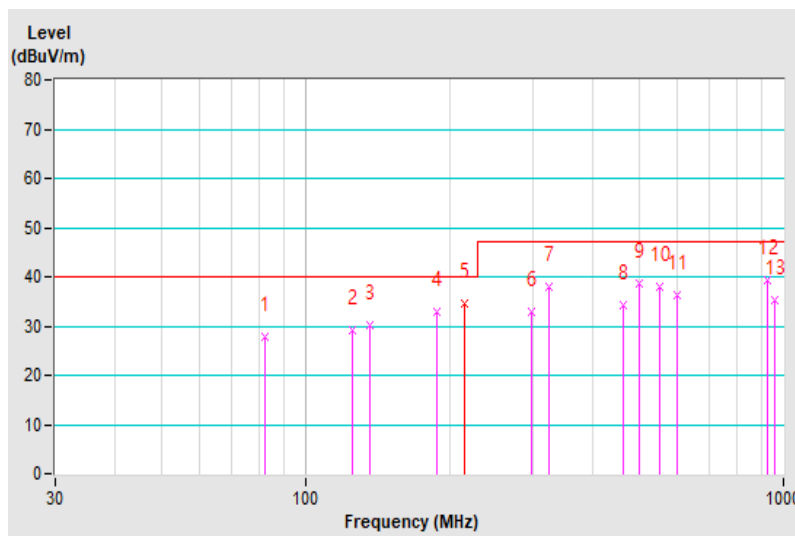

Frequency Range	30MHz ~ 1GHz	Detector Function & Resolution Bandwidth	Quasi-Peak (QP), 120kHz
Tested By	Paul Chen	Environmental Conditions	21.0°C, 73.0%RH, 1006mbar
Test Mode	Mode 1	Test Date	2021/3/19

Antenna Polarity & Test Distance : Vertical at 10 m								
No	Frequency (MHz)	Emission Level (dBuV/m)	Limit (dBuV/m)	Margin (dB)	Antenna Height (m)	Table Angle (Degree)	Raw Value (dBuV)	Correction Factor (dB/m)
1	82.29	31.09 QP	40.00	-8.91	1.73 V	295	46.48	-15.39
2	96.19	27.89 QP	40.00	-12.11	1.00 V	111	42.89	-15.00
3	141.27	30.36 QP	40.00	-9.64	1.00 V	299	40.05	-9.69
4	154.01	30.08 QP	40.00	-9.92	1.00 V	25	39.22	-9.14
5	189.02	32.64 QP	40.00	-7.36	1.00 V	334	44.52	-11.88
6	222.02	33.95 QP	40.00	-6.05	1.00 V	297	45.74	-11.79
7	249.99	30.87 QP	47.00	-16.13	1.00 V	225	40.67	-9.80
8	324.09	36.53 QP	47.00	-10.47	1.00 V	248	43.52	-6.99
9	480.01	36.83 QP	47.00	-10.17	1.00 V	145	40.77	-3.94
10	499.99	33.06 QP	47.00	-13.94	1.00 V	210	36.54	-3.48
11	600.01	34.68 QP	47.00	-12.32	3.25 V	249	35.80	-1.12
12	924.01	38.87 QP	47.00	-8.13	2.19 V	87	33.15	5.72
13	960.01	35.93 QP	47.00	-11.07	1.98 V	352	29.66	6.27

Remarks:

1. Emission Level(dBuV/m) = Raw Value(dBuV) + Correction Factor(dB/m)
2. Correction Factor(dB/m) = Antenna Factor (dB/m) + Cable Factor (dB) – Pre-Amplifier Factor (dB)
3. The other emission levels were very low against the limit.
4. Margin value = Emission level – Limit value

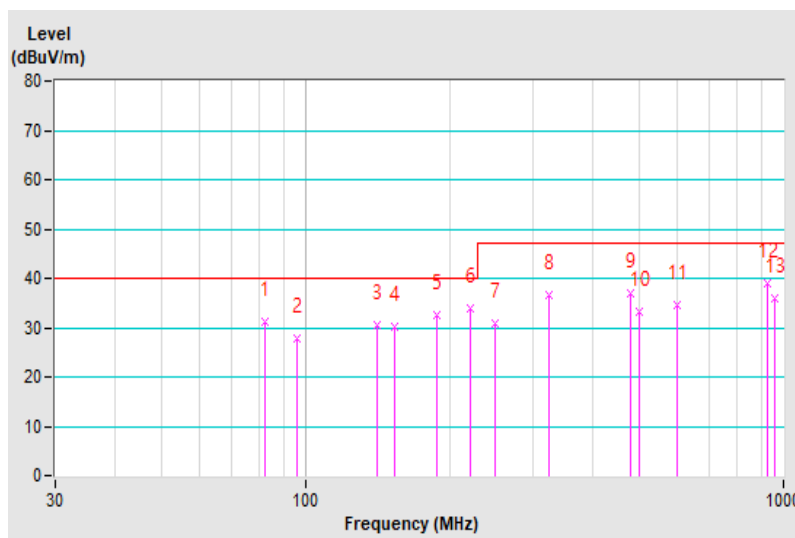

8 Radiated Emission at Frequencies above 1GHz

8.1 Limits

Class A			
Frequency range (MHz)	Distance (m)	Detector type	Limits (dBuV/m)
1000 - 3000	3	Average	56
3000 - 6000			60
1000 - 3000		Peak	76
3000 - 6000			80
Class B			
Frequency range (MHz)	Distance (m)	Detector type	Limits (dBuV/m)
1000 - 3000	3	Average	50
3000 - 6000			54
1000 - 3000		Peak	70
3000 - 6000			74

Note: The lower limit shall apply at the transition frequencies.

Required highest frequency for radiated measurement

Highest internal frequency (F_x) (MHz)	Highest measured frequency
$F_x \leq 108$ MHz	1 GHz
108 MHz < $F_x \leq 500$ MHz	2 GHz
500 MHz < $F_x \leq 1$ GHz	5 GHz
$F_x > 1$ GHz	5 x F_x up to a maximum of 6 GHz

NOTE 1 For FM and TV broadcast receivers, F_x is determined from the highest frequency generated or used excluding the local oscillator and tuned frequencies.

NOTE 2 F_x is highest fundamental frequency generated or used within the EUT or highest frequency at which it operates.

NOTE 3 For outdoor units of home satellite receiving systems highest measured frequency shall be 18 GHz.

Where F_x is unknown, the radiated emission measurements shall be performed up to 6 GHz.

8.2 Test Instruments

Description & Manufacturer	Model No.	Serial No.	Cal. Date	Cal. Due
Agilent Spectrum	E4446A	MY51100009	Jun. 23, 2020	Jun. 22, 2021
Agilent Test Receiver	N9038A	MY50010135	May 29, 2020	May 28, 2021
EMCI Preamplifier	EMC0126545	980076	Feb. 19, 2021	Feb. 18, 2022
MITEQ Preamplifier	AMF-6F-260400-33-8P	892164	Feb. 19, 2021	Feb. 18, 2022
EMCI Preamplifier	EMC184045B	980235	Feb. 19, 2021	Feb. 18, 2022
ETS Preamplifier	3117-PA	00215857	Nov. 23, 2020	Nov. 22, 2021
Schwarzbeck Horn Antenna	BBHA-9170	212	Nov. 22, 2020	Nov. 21, 2021
EMCO Horn Antenna	3115	9312-4192	Nov. 22, 2020	Nov. 21, 2021
Max Full. Turn Table & Tower	MF7802	MF780208103	NA	NA
Software	Radiated_V8.7.08	NA	NA	NA
SUHNER RF cable With 3/4dB PAD	SF102	Cable-CH7-3.6m	Jul. 9, 2020	Jul. 8, 2021
MICRO-TRONICS Notch filter	BRC50703-01	010	May 29, 2020	May 28, 2021
MICRO-TRONICS Band Pass Filter	BRM17690	005	May 29, 2020	May 28, 2021

- Note:
1. The calibration interval of the above test instruments is 12 months and the calibrations are traceable to NML/ROC and NIST/USA.
 2. The 3dB beamwidth of the horn antenna is minimum 40 degree (or $w = 2.18m$ at 3m distance) for 1~6 GHz.
 3. The test was performed in Chamber No. 7.
 4. The VCCI Site Registration No. G-10039
 5. Tested Date: Mar. 24, 2021

8.3 Test Arrangement

- The EUT was placed on the top of a rotating table 0.8 meters above the ground at an accredited chamber room. The table was rotated 360 degrees to determine the position of the highest radiation.
- The EUT was set 3 meters away from the interference-receiving antenna, which was mounted on the top of a variable-height antenna tower.
- The height of antenna can be varied from one meter to four meters, the height of adjustment depends on the EUT height and the antenna 3dB beamwidth both, to detect the maximum value of the field strength. Both horizontal and vertical polarizations of the antenna are set to make the measurement.
- For each suspected emission, the EUT was arranged to its worst case and then the antenna was tuned to heights and the rotatable table was turned from 0 degrees to 360 degrees to find the maximum reading.
- The spectrum analyzer system was set to peak and average detect function and specified bandwidth with maximum hold mode when the test frequency is above 1 GHz.

Note:

- The resolution bandwidth of test receiver/spectrum analyzer is 1MHz and video bandwidth is 3MHz for Peak detection (PK) at frequency above 1GHz. The resolution bandwidth of test receiver/spectrum analyzer is 1 MHz for Average detection (AV) at frequency above 1GHz.
- The measurement distance is the shortest horizontal distance between an imaginary circular periphery just encompassing this arrangement and the calibration point of the antenna.

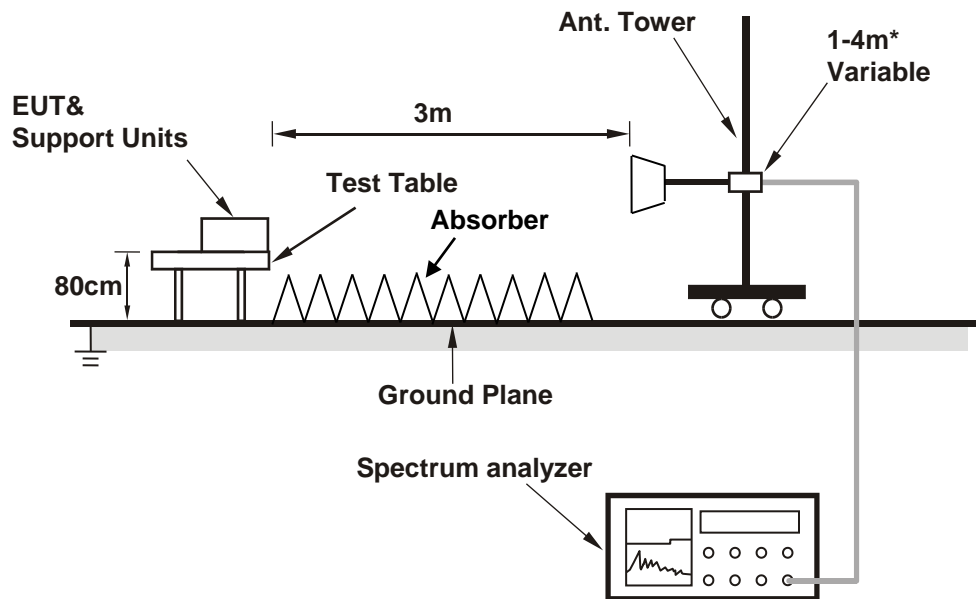

Note: Cable on the RGP must be insulated.

* :depends on the EUT height and the antenna 3dB beamwidth both.

For the actual test configuration, please refer to the related item – Photographs of the Test Configuration.

8.4 Test Results

Frequency Range	1GHz ~ 6GHz	Detector Function & Resolution Bandwidth	Peak (PK) / Average (AV), 1MHz
Tested By	Chin-Wen Wang	Environmental Conditions	23.0°C, 68.0%RH, 1008mbar
Test Mode	Mode 1	Test Date	2021/3/24

Antenna Polarity & Test Distance : Horizontal at 3 m								
No	Frequency (MHz)	Emission Level (dBuV/m)	Limit (dBuV/m)	Margin (dB)	Antenna Height (m)	Table Angle (Degree)	Raw Value (dBuV)	Correction Factor (dB/m)
1	1791.87	51.40 PK	76.00	-24.60	1.17 H	283	52.47	-1.07
2	1791.87	32.02 AV	56.00	-23.98	1.17 H	283	33.09	-1.07
3	2155.87	53.43 PK	76.00	-22.57	1.52 H	119	52.71	0.72
4	2155.87	42.78 AV	56.00	-13.22	1.52 H	119	42.06	0.72
5	2310.00	58.25 PK	76.00	-17.75	2.10 H	315	57.28	0.97
6	2310.00	45.09 AV	56.00	-10.91	2.10 H	315	44.12	0.97
7	2395.62	53.29 PK	76.00	-22.71	1.07 H	184	52.11	1.18
8	2395.62	39.32 AV	56.00	-16.68	1.07 H	184	38.14	1.18
9	2719.25	53.14 PK	76.00	-22.86	1.96 H	236	51.78	1.36
10	2719.25	34.08 AV	56.00	-21.92	1.96 H	236	32.72	1.36
11	4992.75	53.64 PK	80.00	-26.36	1.00 H	263	47.73	5.91
12	4992.75	36.59 AV	60.00	-23.41	1.00 H	263	30.68	5.91

Remarks:

1. Emission Level(dBuV/m) = Raw Value(dBuV) + Correction Factor(dB/m)
2. Correction Factor(dB/m) = Antenna Factor (dB/m) + Cable Factor (dB) – Pre-Amplifier Factor (dB)
3. The other emission levels were very low against the limit.
4. Margin value = Emission level – Limit value

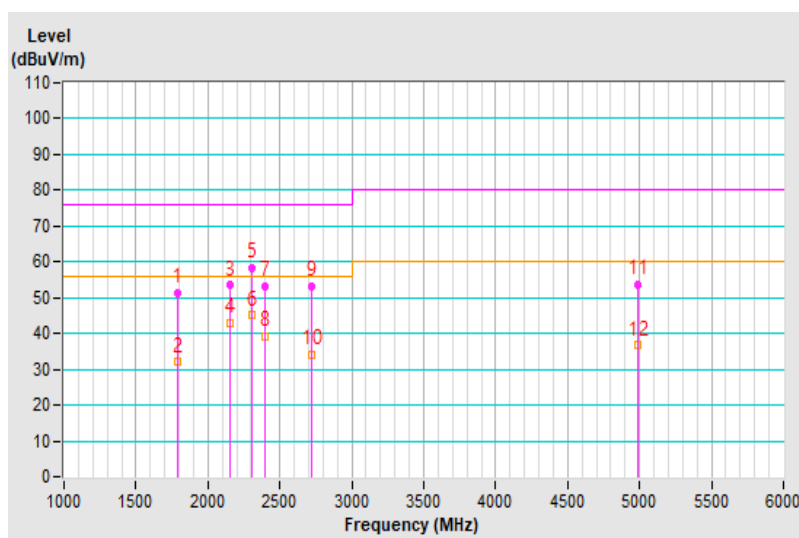

Frequency Range	1GHz ~ 6GHz	Detector Function & Resolution Bandwidth	Peak (PK) / Average (AV), 1MHz
Tested By	Chin-Wen Wang	Environmental Conditions	23.0°C, 68.0%RH, 1008mbar
Test Mode	Mode 1	Test Date	2021/3/24

Antenna Polarity & Test Distance : Vertical at 3 m								
No	Frequency (MHz)	Emission Level (dBuV/m)	Limit (dBuV/m)	Margin (dB)	Antenna Height (m)	Table Angle (Degree)	Raw Value (dBuV)	Correction Factor (dB/m)
1	1773.87	53.73 PK	76.00	-22.27	1.57 V	238	55.04	-1.31
2	1773.87	34.28 AV	56.00	-21.72	1.57 V	238	35.59	-1.31
3	2165.62	55.53 PK	76.00	-20.47	2.54 V	31	54.78	0.75
4	2165.62	34.63 AV	56.00	-21.37	2.54 V	31	33.88	0.75
5	2309.87	58.03 PK	76.00	-17.97	1.95 V	301	57.06	0.97
6	2309.87	43.77 AV	56.00	-12.23	1.95 V	301	42.80	0.97
7	2782.50	57.23 PK	76.00	-18.77	1.38 V	189	55.75	1.48
8	2782.50	36.23 AV	56.00	-19.77	1.38 V	189	34.75	1.48
9	4995.12	55.95 PK	80.00	-24.05	2.10 V	300	50.02	5.93
10	4995.12	39.73 AV	60.00	-20.27	2.10 V	300	33.80	5.93
11	5992.87	54.36 PK	80.00	-25.64	1.00 V	311	47.64	6.72
12	5992.87	38.58 AV	60.00	-21.42	1.00 V	311	31.86	6.72

Remarks:

1. Emission Level(dBuV/m) = Raw Value(dBuV) + Correction Factor(dB/m)
2. Correction Factor(dB/m) = Antenna Factor (dB/m) + Cable Factor (dB) – Pre-Amplifier Factor (dB)
3. The other emission levels were very low against the limit.
4. Margin value = Emission level – Limit value

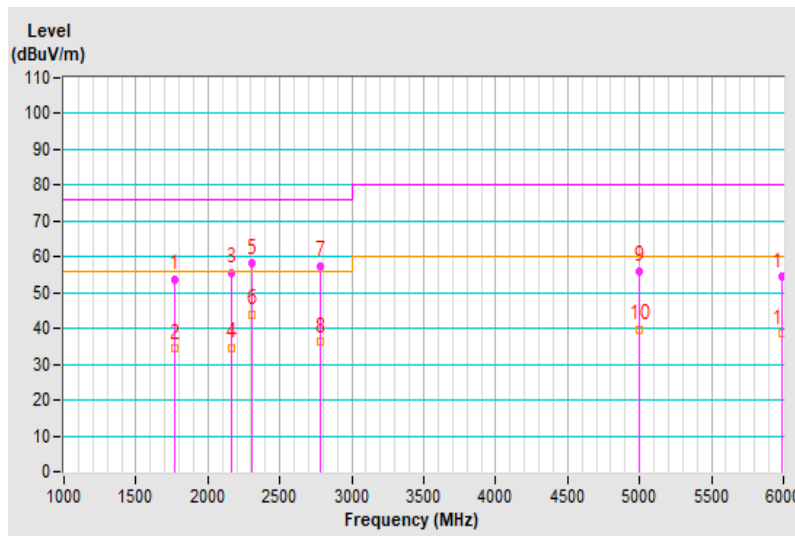

9 Harmonics Current Measurement

9.1 Limits

Limits for Class A equipment		Limits for Class D equipment		
Harmonic Order n	Max. permissible harmonics current A	Harmonic Order n	Max. permissible harmonics current per watt mA/W	Max. permissible harmonics current A
Odd harmonics		Odd Harmonics only		
3	2.30	3	3.4	2.30
5	1.14	5	1.9	1.14
7	0.77	7	1.0	0.77
9	0.40	9	0.5	0.40
11	0.33	11	0.35	0.33
13	0.21	13	0.30	0.21
15 ≤ n ≤ 39	0.15 x 15/n	15 ≤ n ≤ 39	3.85/n	0.15 x 15/n
Even harmonics				
2	1.08			
4	0.43			
6	0.30			
8 ≤ n ≤ 40	0.23 x 8/n			

Notes: 1. Class A and Class D are classified according to section 5 of EN 61000-3-2.
 2. According to section 7 of EN 61000-3-2, the above limits for all equipment except for lighting equipment having an active input power > 75 W and no limits apply for equipment with an active input power up to and including 75 W.

9.2 Classification of Equipment

Class A	Class B	Class C	Class D
Balanced three-phase equipment; Household appliances excluding equipment as Class D; Tools excluding portable tools; Dimmers for incandescent lamps; Audio equipment; Equipment not specified in one of the three other classes.	Portable tools; Arc welding equipment which is not professional equipment.	Lighting equipment.	Equipment having a specified power less than or equal to 600 W of the following types: Personal computers and personal computer monitors; Television receivers; Refrigerators and freezers having one or more variable-speed drives to control compressor motor(s).

9.3 Test Instruments

Description & Manufacturer	Model No.	Serial No.	Cal. Date	Cal. Due
Teseq Harmonics - Flicker Test System	Proflin 2105	32A00983 & 1639A01863	Sep. 16, 2020	Sep. 15, 2021
Software	CTS 4	NA	NA	NA

Note: 1. The calibration interval of the above test instruments is 12 months and the calibrations are traceable to NML/ROC and NIST/USA.
 2. The test was performed in EMS Room No. 1.
 3. According to IEC 61000-4-7: 2002, the time window shall be synchronized with each group of 10 or 12 cycles (200 ms) for power frequency of 50 or 60Hz.
 4. Tested Date: Mar. 26, 2021

9.4 Test Arrangement

- a. The EUT was placed on the top of a wooden table 0.8 meters above the ground and operated to produce the maximum harmonic components under normal operating conditions for each successive harmonic component in turn.
- b. The correspondent test program of test instrument to measure the current harmonics emanated from EUT is chosen. The measure time shall be not less than the time necessary for the EUT to be exercised.

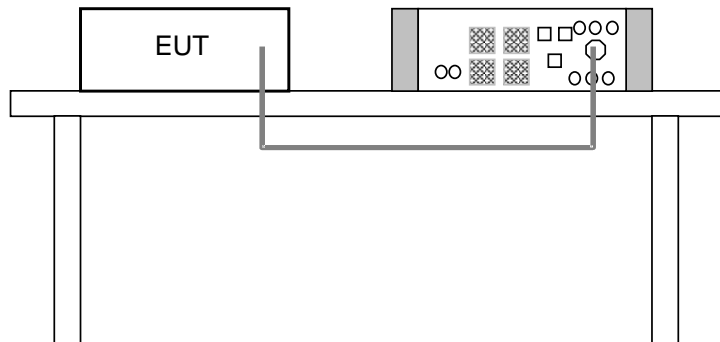

For the actual test configuration, please refer to the related item – Photographs of the Test Configuration.

9.5 Test Results

Fundamental Voltage/Ampere	230.51Vrms/ 0.565Arms	Power Frequency	50.00Hz
Power Consumption	117.2W	Power Factor	0.902
Environmental Conditions	20°C, 82% RH	Tested by	Chiming Li
Test Mode	Mode 1	Test Date	2021/3/26

Harm#	Harms (avg) (A)	100% Limit (A)	Harms (max) (A)	150% Limit (A)	Test Result
3	0.161	0.399	0.179	0.598	Pass
5	0.035	0.223	0.040	0.334	Pass
7	0.023	0.117	0.027	0.176	Pass
9	0.002	0.059	0.005	0.088	Pass
11	0.006	0.041	0.008	0.062	Pass
13	0.007	0.035	0.007	0.053	Pass
15	0.008	0.030	0.010	0.046	Pass
17	0.006	0.027	0.007	0.040	Pass
19	0.002	0.024	0.004	0.036	Pass
21	0.011	0.021	0.012	0.032	Pass
23	0.006	0.020	0.007	0.029	Pass
25	0.008	0.018	0.009	0.027	Pass
27	0.004	0.017	0.010	0.025	Pass
29	0.007	0.016	0.011	0.023	Pass
31	0.003	0.015	0.004	0.022	Pass
33	0.005	0.014	0.006	0.020	Pass
35	0.004	0.013	0.006	0.019	Pass
37	0.003	0.012	0.004	0.018	Pass
39	0.161	0.399	0.179	0.598	Pass

Note: Dynamic limits were applied for this test. The highest harmonics values in the above table may not occur at the same window as the maximum harmonics/limit ratio.

10 Voltage Fluctuations and Flicker Measurement

10.1 Limits

Test item	Limit	Note
P_{st}	1.0	P_{st} : short-term flicker severity.
P_{lt}	0.65	P_{lt} : long-term flicker severity.
T_{max} (ms)	500	T_{max} : maximum time duration during the observation period that the voltage deviation $d(t)$ exceeds the limit for d_c .
d_{max} (%)	4	d_{max} : maximum absolute voltage change during an observation period.
d_c (%)	3.3	d_c : maximum steady state voltage change during an observation period.

10.2 Test Instruments

Description & Manufacturer	Model No.	Serial No.	Cal. Date	Cal. Due
Teseq Harmonics - Flicker Test System	Proflin 2105	32A00983 & 1639A01863	Sep. 16, 2020	Sep. 15, 2021
Software	CTS 4	NA	NA	NA

Note: 1. The calibration interval of the above test instruments is 12 months and the calibrations are traceable to NML/ROC and NIST/USA.
 2. The test was performed in EMS Room No. 1.
 3. Tested Date: Mar. 26, 2021

10.3 Test Arrangement

- The EUT was placed on the top of a wooden table 0.8 meters above the ground and operated to produce the most unfavorable sequence of voltage changes under normal operating conditions.
- During the flick measurement, the measure time shall include that part of whole operation cycle in which the EUT produce the most unfavorable sequence of voltage changes. The observation period for short-term flicker indicator is 10 minutes and the observation period for long-term flicker indicator is 2 hours.

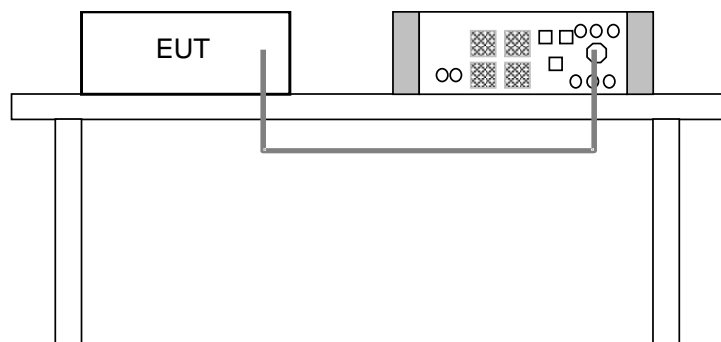

For the actual test configuration, please refer to the related item – Photographs of the Test Configuration.

10.4 Test Results

Fundamental Voltage/Ampere	230.51Vrms/ 0.565Arms	Power Frequency	50.00Hz
Observation (T_p)	10 min.	Power Factor	0.902
Environmental Conditions	20°C, 82% RH	Tested by	Chiming Li
Test Mode	Mode 1	Test Date	2021/3/26

Test Parameter	Measurement Value	Limit	Remarks
P_{st}	0.319	1.00	Pass
P_{lt}	0.139	0.65	Pass
T_{max} (ms)	0	500	Pass
d_{max} (%)	0	4	Pass
d_c (%)	0	3.3	Pass

- Note: (1) P_{st} means short-term flicker indicator.
 (2) P_{lt} means long-term flicker indicator.
 (3) T_{max} means accumulated time value of $d(t)$ with a deviation exceeding 3.3 %.
 (4) d_{max} means maximum relative voltage change.
 (5) d_c means maximum relative steady-state voltage change.

11 General Immunity Requirements

EN 55035:2017 +A11:2020 , Immunity requirements

Reference standard	Test specification	Performance Criterion
EN/IEC 61000-4-2 ESD	Enclosure port: ±8kV Air discharge, ±4kV Contact discharge	B
EN/IEC 61000-4-3 RS	Enclosure port: Swept freq. test : 80-1000 MHz, 3V/m, 80% AM (1kHz), Spot freq. test : 1800, 2600, 3500, 5000 MHz (±1 %), 3V/m, 80% AM (1kHz)	A
EN/IEC 61000-4-4 EFT	Analogue/digital data ports (cable length > 3m): xDSL equipment: ±0.5kV, 5/50 (t _r /t _w) ns, 100kHz others: ±0.5kV, 5/50 (t _r /t _w) ns, 5kHz	B
	DC network power port(cable length > 3m): ±0.5kV, 5/50 (t _r /t _w) ns, 5kHz	
	AC mains power ports: ±1.0kV, 5/50 (t _r /t _w) ns, 5kHz	
EN/IEC 61000-4-5 Surge	Analogue/digital data ports (direct to outdoor cables): Port type: unshielded symmetrical 10/700(5/320) (T _r /T _d) μs, w/o primary protectors (line to ground): ±1.0kV, or with primary protectors (line to ground): ±1.0kV, ±4.0kV Port type: coaxial or shielded 1.2/50 (8/20) (T _r /T _d) μs, shield to ground: ±0.5kV	C
	DC network power port (direct to outdoor cables): 1.2/50(8/20) (T _r /T _d) μs, Line to ground: ±0.5kV	B
	AC mains power ports: 1.2/50(8/20) (T _r /T _d) μs, Line to line: ±1kV, Line to ground: ±2kV	B
EN/IEC 61000-4-6 CS	Analogue/digital data ports (cable length > 3m) ; DC network power ports (cable length > 3m) ; AC mains power ports 0.15-10 MHz, 3V, 80% AM (1kHz), 10-30 MHz, 3V-1V, 80% AM (1kHz), 30-80 MHz, 1V, 80% AM (1kHz)	A
EN/IEC 61000-4-8 PFMF	Enclosure port: 50 or 60 Hz, 1A/m	A
EN/IEC 61000-4-11 Voltage Dips & Interruptions	AC mains power ports: (at 50 Hz) Voltage Dips: <5% residual – 0.5 cycle 70% residual – 25 cycles	B C
	AC mains power ports: Voltage Interruptions: <5% residual – 250 cycles	C

11.1 Performance Criteria

General Performance Criteria

Performance criterion A

The equipment shall continue to operate as intended without operator intervention. No degradation of performance or loss of function is allowed below a performance level specified by the manufacturer when the equipment is used as intended. The performance level may be replaced by a permissible loss of performance. If the minimum performance level or the permissible performance loss is not specified by the manufacturer, then either of these may be derived from the product description and documentation, and by what the user may reasonably expect from the equipment if used as intended.

Performance criterion B

After the test, the equipment shall continue to operate as intended without operator intervention. No degradation of performance or loss of function is allowed, after the application of the phenomena below a performance level specified by the manufacturer, when the equipment is used as intended. The performance level may be replaced by a permissible loss of performance. During the test, degradation of performance is allowed. However, no change of operating state or stored data is allowed to persist after the test. If the minimum performance level (or the permissible performance loss) is not specified by the manufacturer, then either of these may be derived from the product description and documentation, and by what the user may reasonably expect from the equipment if used as intended.

Performance criterion C

Loss of function is allowed, provided the function is self-recoverable, or can be restored by the operation of the controls by the user in accordance with the manufacturer's instructions. Functions, and/or information stored in non-volatile memory, or protected by a battery backup, shall not be lost.

Product Specific Performance Criteria

The particular performance criteria which are specified in the normative annexes of EN 55035 take precedence over the corresponding parts of the general performance criteria. Where particular performance criteria for specific functions are not given, then the general performance criteria shall apply.

12 Electrostatic Discharge Immunity Test (ESD)

12.1 Test Specification

Basic Standard:	EN/IEC 61000-4-2
Discharge Impedance:	330 ohm / 150 pF
Discharge Voltage:	Air Discharge: $\pm 2, \pm 4, \pm 8$ kV (Direct) Contact Discharge: $\pm 2, \pm 4$ kV (Indirect/ Direct)
Number of Discharge:	Air – Direct: 10 discharges per location (each polarity) Contact – Direct & Indirect: 10 discharges per location (each polarity)
Discharge Mode:	Single Discharge
Discharge Period:	1-second minimum

12.2 Test Instruments

Description & Manufacturer	Model No.	Serial No.	Cal. Date	Cal. Due
KeyTek, ESD Simulator	MZ-15/EC	0504259	Nov. 6, 2020	Nov. 5, 2021

- Note:
1. The calibration interval of the above test instruments is 12 months and the calibrations are traceable to NML/ROC and NIST/USA.
 2. The test was performed in ESD Room No. 1.
 3. Tested Date: Apr. 13, 2021

12.3 Test Arrangement

The basic test procedure was in accordance with EN/IEC 61000-4-2:

- a. Electrostatic discharges were applied only to those points and surfaces of the EUT that are accessible to users during normal operation.
- b. The test was performed with at least ten single discharges on the pre-selected points in the most sensitive polarity.
- c. The time interval between two successive single discharges was at least 1 second.
- d. The ESD generator was held perpendicularly to the surface to which the discharge was applied and the return cable was at least 0.2 meters from the EUT.
- e. Contact discharges were applied to the non-insulating coating, with the pointed tip of the generator penetrating the coating and contacting the conducting substrate.
- f. Air discharges were applied with the round discharge tip of the discharge electrode approaching the EUT as fast as possible (without causing mechanical damage) to touch the EUT. After each discharge, the ESD generator was removed from the EUT and re-triggered for a new single discharge. The test was repeated until all discharges were complete.
- g. At least ten single discharges (in the most sensitive polarity) were applied to the **Horizontal Coupling Plane** at points on each side of the EUT. The ESD generator was positioned at a distance of 0.1 meters from the EUT with the discharge electrode touching the **HCP**.
- h. At least ten single discharges (in the most sensitive polarity) were applied to the center of one vertical edge of the **Vertical Coupling Plane** in sufficiently different positions that the four faces of the EUT were completely illuminated. The **VCP** (dimensions 0.5m x 0.5m) was placed vertically to and 0.1 meters from the EUT.

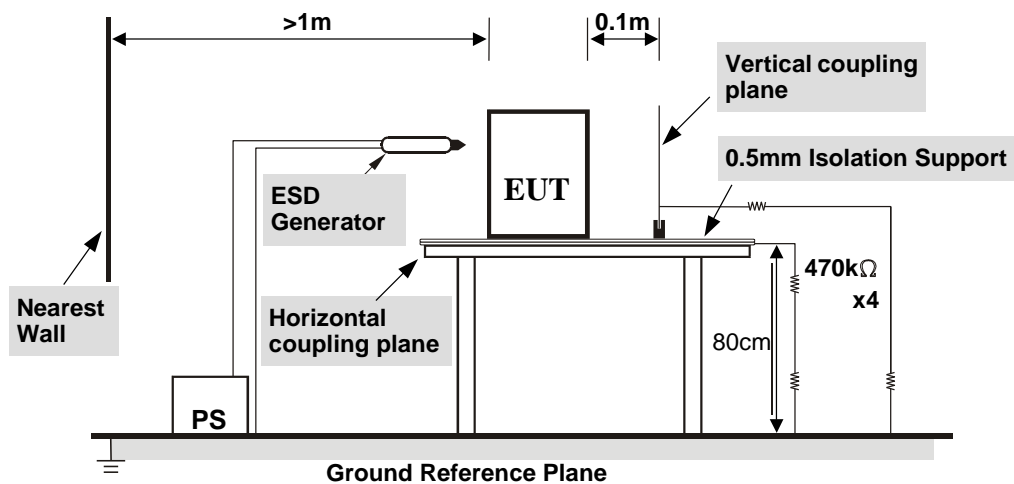

TABLE-TOP EQUIPMENT

The configuration consisted of a wooden table 0.8 meters high standing on the **Ground Reference Plane**. The **GRP** consisted of a sheet of aluminum at least 0.25mm thick, and 2.5 meters square connected to the protective grounding system. A **Horizontal Coupling Plane** (1.6m x 0.8m) was placed on the table and attached to the **GRP** by means of a cable with 940kΩ total impedance. The equipment under test, was installed in a representative system as described in section 7 of EN/IEC 61000-4-2, and its cables were placed on the **HCP** and isolated by an insulating support of 0.5mm thickness. A distance of 1-meter minimum was provided between the EUT and the walls of the laboratory and any other metallic structure.

For the actual test configuration, please refer to the related item – Photographs of the Test Configuration.

12.4 Test Results

Input Power	230 Vac, 50 Hz	Tested by	Kent Wang
Environmental conditions	22 °C, 48% RH 1007 mbar	Test Date	2021/4/13
Test mode	Mode 1		

Test Results of Direct Application					
Discharge Level (kV)	Polarity (+/-)	Test Point	Contact Discharge	Air Discharge	Performance Criterion
2, 4	+/-	1-6	Note 1	NA	A
2, 4, 8	+/-	9, 11-16	NA	Note 1	A
2, 4	+/-	7, 8, 10	NA	Note 1	A
8	+/-	7, 8	NA	Note 2	B
8	+/-	10	NA	Note 2, 3	B

Description of test points of direct application: Please refer to following page for representative mark only.

Test Results of Indirect Application					
Discharge Level (kV)	Polarity (+/-)	Test Point	Horizontal Coupling Plane	Vertical Coupling Plane	Performance Criterion
2, 4	+/-	Four Sides	Note 1	Note 1	A

Description of test points of indirect application:

1. Front side 2. Rear side 3. Right side 4. Left side

- Note: 1. The EUT function was correct during the test.
 2. The image on the screen disappeared during the test, but self-recoverable after the test.
 3. PoE camera ping time out during the test, but self-recoverable after the test.

Description of Test Points

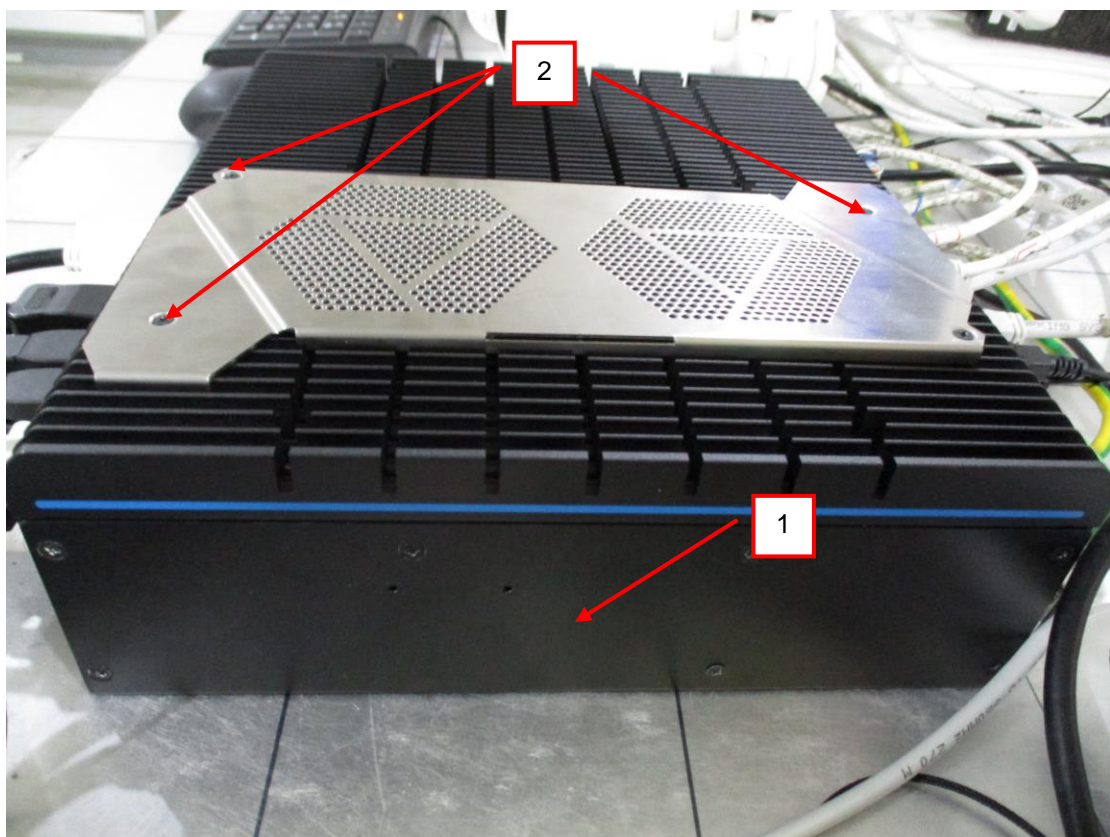
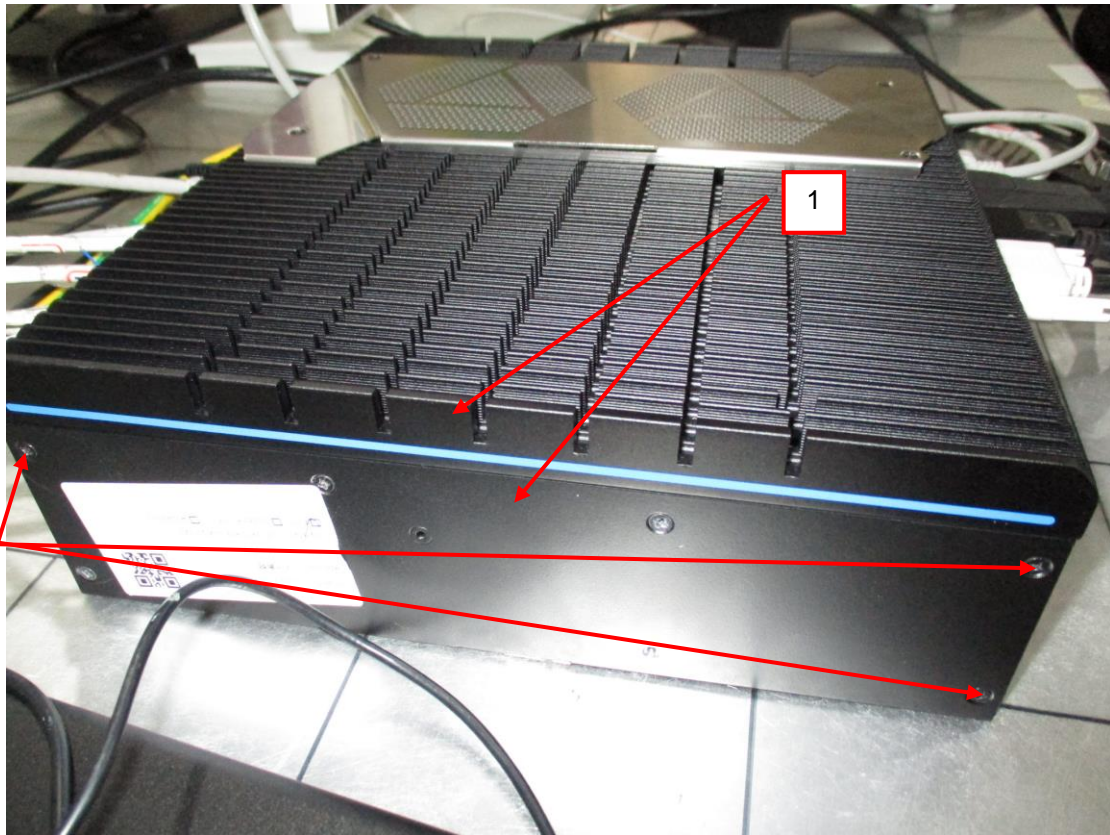

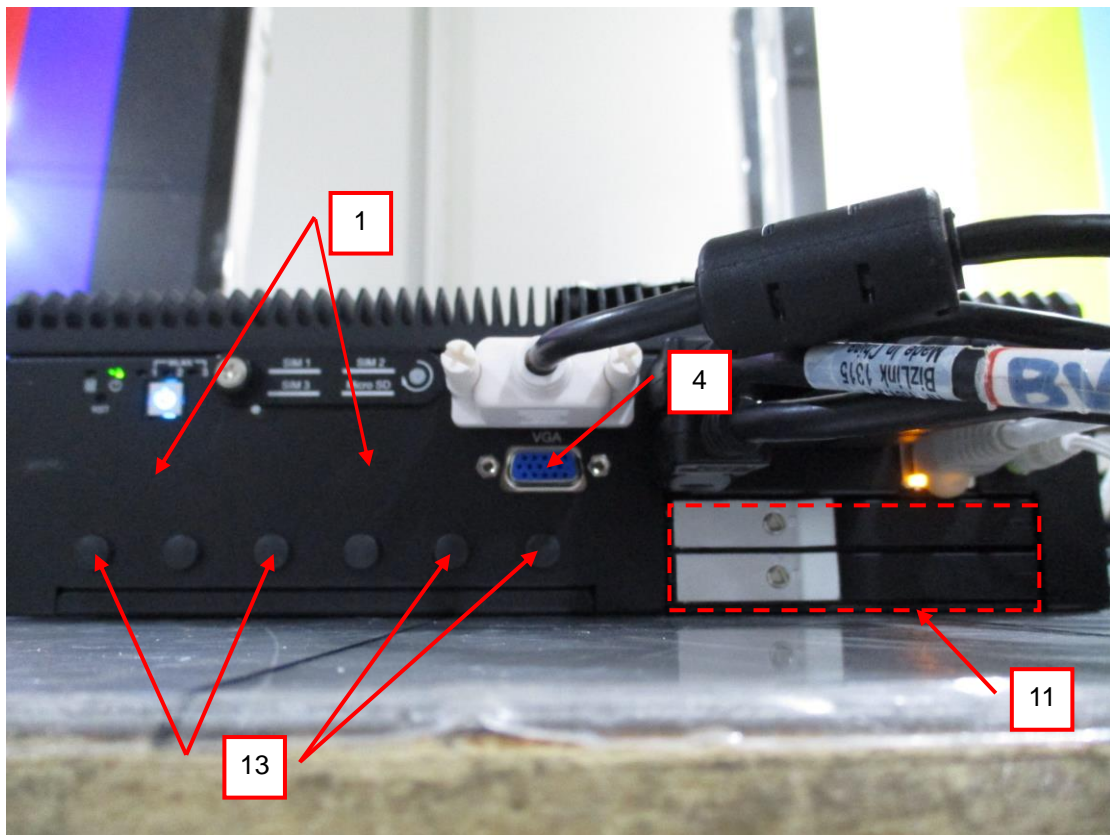
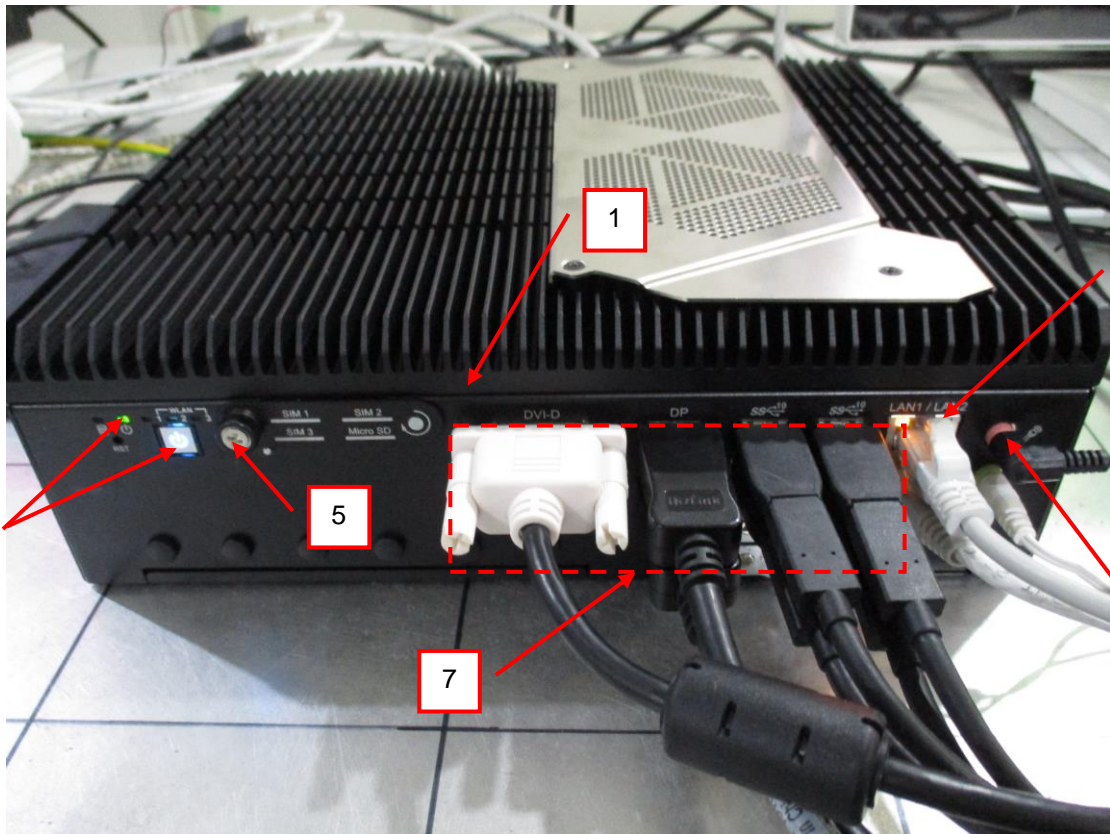

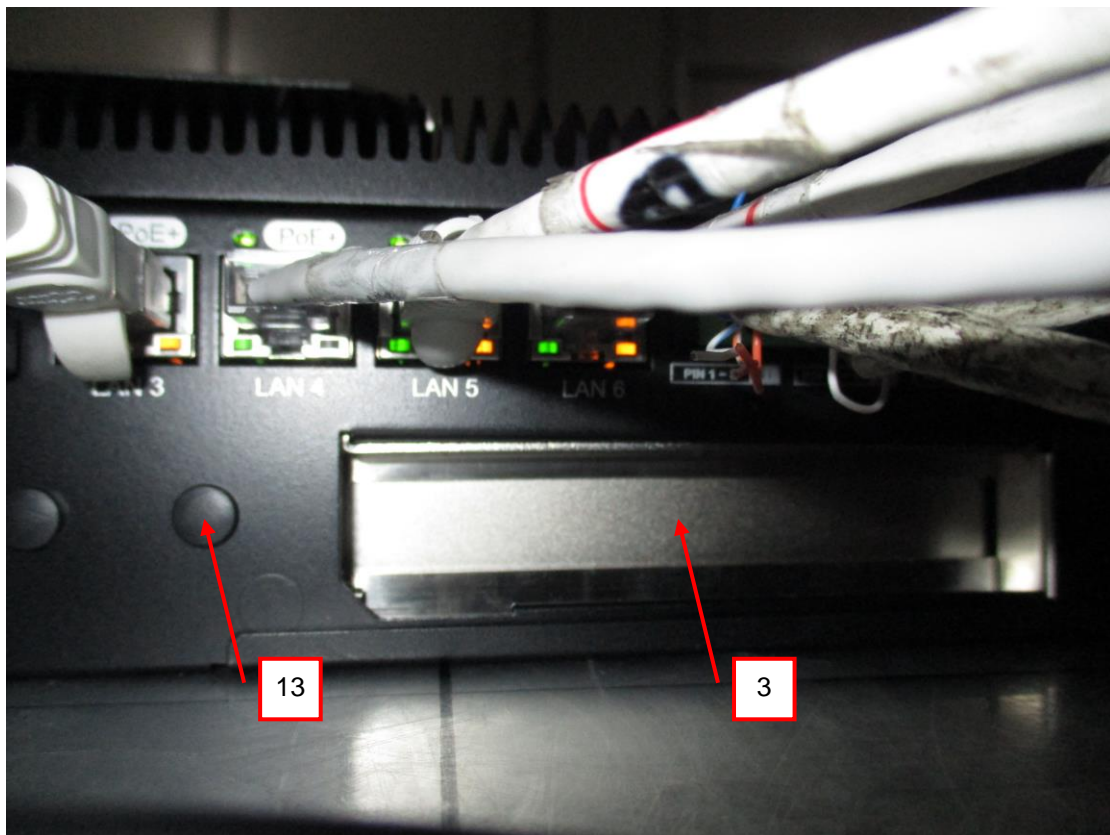
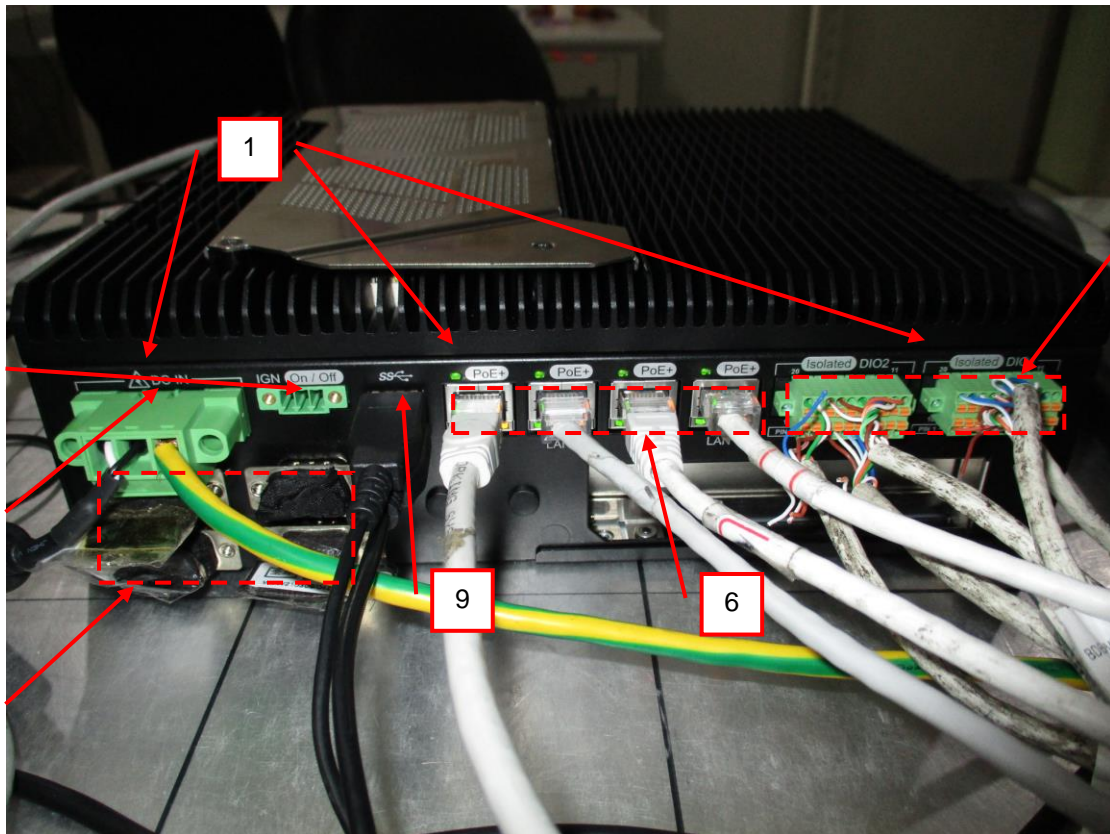



13 Radiated, Radio-frequency, Electromagnetic Field Immunity Test (RS)

13.1 Test Specification

Basic Standard:	EN/IEC 61000-4-3
Swept Frequency Range:	80 MHz - 1000 MHz
Spot Frequencies:	1800, 2600, 3500, 5000 MHz ($\pm 1\%$)
Field Strength:	3 V/m
Modulation:	1kHz Sine Wave, 80%, AM Modulation
Frequency Step:	1 % of preceding frequency value
Polarity of Antenna:	Horizontal and Vertical
Antenna Height:	1.5m
Dwell Time:	3 seconds

13.2 Test Instruments

Description & Manufacturer	Model No.	Serial No.	Cal. Date	Cal. Due
AgilentSignal Generator	E8257D	MY48050465	Jun. 8, 2020	Jun. 7, 2021
BONN RF Amplifier	BSA 0125-800	1912556	NA	NA
TESTQAmplifier	CBA 1G-275	T44344	NA	NA
AR RF Amplifier	35S4G8AM4	0326094	NA	NA
AR RF Amplifier	100S1G4M3	0329249	NA	NA
AR Controller	SC1000M3	305910	NA	NA
ARLog-Periodic Antenna	AT6080	0329465	NA	NA
BOONTON RF Voltage Meter	4232A	10180	May 29, 2020	May 28, 2021
BOONTON Power Sensor	51011-EMC	34152	May 29, 2020	May 28, 2021
BOONTON Power Sensor	51011-EMC	34153	May 29, 2020	May 28, 2021
EMCO BiconiLog Antenna	3141	1001	NA	NA
ARHigh Gain Antenna	AT4010	0329800	NA	NA
SchwarzbeckLOG ANTENNA	Stlp 9149	9149-260	NA	NA
CHANCE MOST Full Anechoic Chamber (9x5x3m)	Chance Most	RS-002	Feb. 4, 2021	Feb. 3, 2022
Software	RS_V7.6	NA	NA	NA
Microphone (Ear Simulator)	4192	3190854	Jan. 7, 2021	Jan. 6, 2022
Conditioning Amplifier	2690-0S2	2645274	May 11, 2020	May 10, 2021
B&K Ear Simulator	4185	2553594	NA	NA
ROHDE & SCHWARZ AUDIO ANALYZER	UPV	104565	May 26, 2020	May 25, 2021
Software	ABMS_V7.4.3	NA	NA	NA

- Note:
1. The calibration interval of the above test instruments is 12 months and the calibrations are traceable to NML/ROC and NIST/USA.
 2. The test was performed in RS Room No.2.
 3. The transmit antenna was located at a distance of 3 meters from the EUT.
 4. Tested Date: Mar. 30, 2021

13.3 Test Arrangement

The test procedure was in accordance with EN/IEC 61000-4-3.

- a. The testing was performed in a fully anechoic chamber.
- b. The swept frequency range is from 80 MHz to 1000 MHz and the spot frequencies are 1800, 2600, 3500, 5000 MHz ($\pm 1\%$), with the signal 80% amplitude modulated with a 1kHz sine wave.
- c. The dwell time of the amplitude modulated carrier was applied in 3 s at each of the frequencies during the scan. The sensitive frequencies (e.g. clock frequencies or frequencies identified by the manufacturer or obtained as outcome of the test) shall be analyzed in addition to the stepped frequencies.
- d. The field strength level was 3 V/m.
- e. The test was performed with the EUT exposed to both vertically and horizontally polarized fields on each of the four sides.

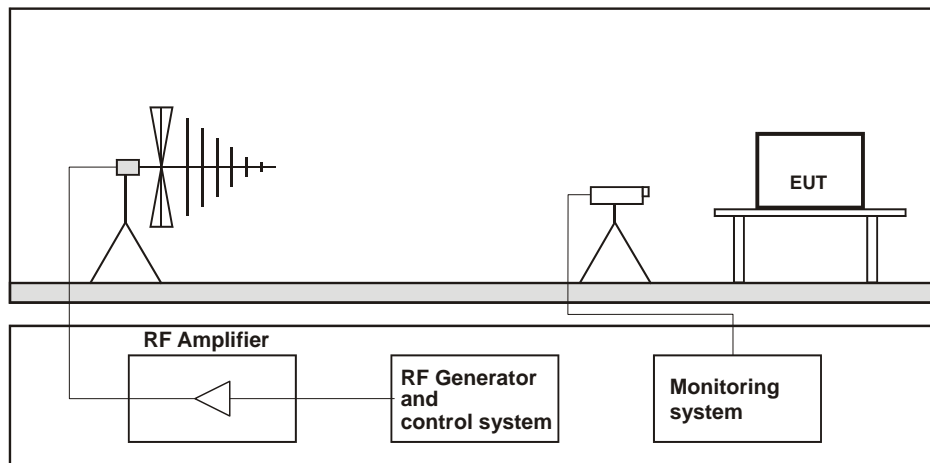

Table-top Equipment

The EUT installed in a representative system as described in section 7 of EN/IEC 61000-4-3 was placed on a non-conductive table 0.8 meters in height. The system under test was connected to the power and signal wire according to relevant installation instructions.

For the actual test configuration, please refer to the related item – Photographs of the Test Configuration.

13.4 Test Results

Input Power	230 Vac, 50 Hz	Tested by	Sean Chou
Environmental conditions	22 °C, 70% RH	Test Date	2021/3/30
Test mode	Mode 1		

Frequency (MHz)	Polarity	Azimuth(°)	Applied Field Strength		Observation	Performance Criterion	Remark
			(V/m)	Modulation			
80 - 1000	V&H	0	3	80% AM (1kHz)	Note	A	-
		90	3	80% AM (1kHz)	Note	A	
		180	3	80% AM (1kHz)	Note	A	
		270	3	80% AM (1kHz)	Note	A	
1800, 2600, 3500, 5000 MHz (±1 %)	V&H	0	3	80% AM (1kHz)	Note	A	
		90	3	80% AM (1kHz)	Note	A	
		180	3	80% AM (1kHz)	Note	A	
		270	3	80% AM (1kHz)	Note	A	
80 - 1000	V&H	0	3	80% AM (1kHz)	Note	A	Audio output function
		90	3	80% AM (1kHz)	Note	A	
		180	3	80% AM (1kHz)	Note	A	
		270	3	80% AM (1kHz)	Note	A	
1800, 2600, 3500, 5000 MHz (±1 %)	V&H	0	3	80% AM (1kHz)	Note	A	
		90	3	80% AM (1kHz)	Note	A	
		180	3	80% AM (1kHz)	Note	A	
		270	3	80% AM (1kHz)	Note	A	

Note: The EUT function was correct during the test.

Remark: Audio out function (Audio out) electrical reference level pass.

14 Electrical Fast Transient/Burst Immunity Test (EFT)

14.1 Test Specification

Basic Standard:	EN/IEC 61000-4-4
Test Voltage:	Analogue/digital data port (cable length > 3m): $\pm 0.5\text{kV}$ DC network power port (cable length > 3m): NA AC mains power port: $\pm 1\text{kV}$
Impulse Repetition Frequency:	100kHz : applicable only to xDSL port 5kHz : others
Impulse Wave Shape :	5/50 ns
Burst Duration:	0.75 ms for 100kHz Repetition Frequency 15 ms for 5kHz Repetition Frequency
Burst Period:	300 ms
Test Duration:	1 min.

14.2 Test Instruments

Description & Manufacturer	Model No.	Serial No.	Cal. Date	Cal. Due
Haefely, EFT Generator	PEFT 4010	154954	Apr. 20, 2020	Apr. 19, 2021
Haefely, Capacitive Clamp	IP4A	155173	Apr. 20, 2020	Apr. 19, 2021

- Note:
1. The calibration interval of the above test instruments is 12 months and the calibrations are traceable to NML/ROC and NIST/USA.
 2. The test was performed in EFT Room.
 3. Tested Date: Mar. 17, 2021

14.3 Test Arrangement

- Both positive and negative polarity discharges were applied.
- The distance between any coupling devices and the EUT should be 0.5 m for table-top equipment testing, and 1.0 m for floor standing equipment.
- The duration time of each test sequential was 1 minute.
- The transient/burst waveform was in accordance with EN/IEC 61000-4-4, 5/50 ns.

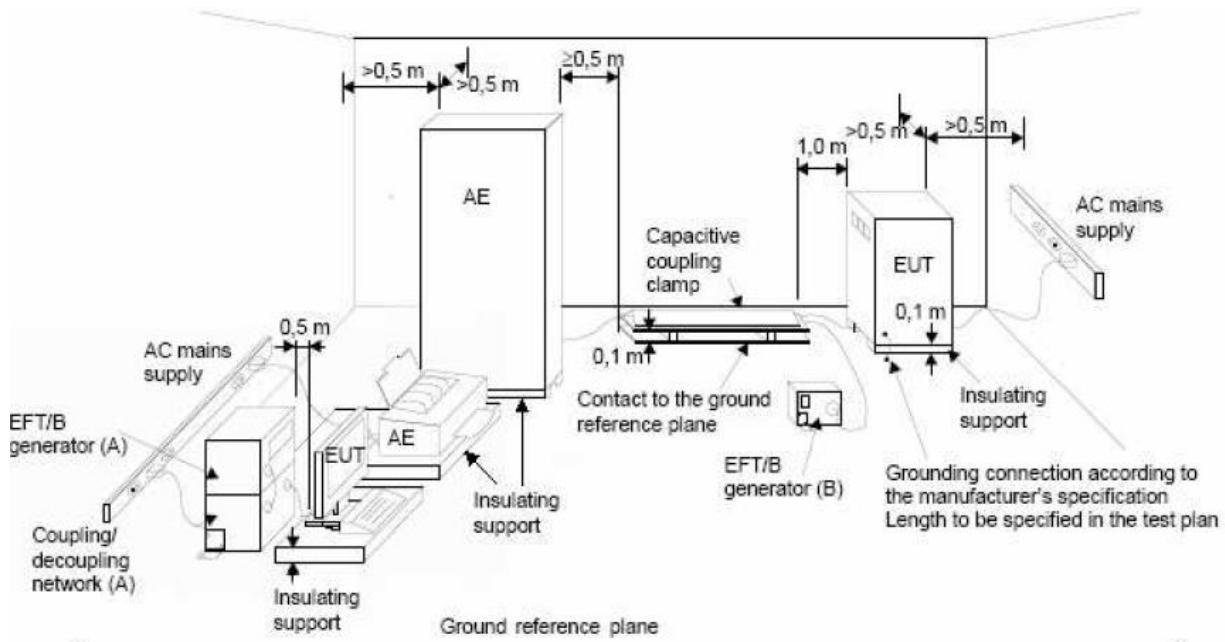

NOTE:

- location for supply line coupling
- location for signal lines coupling

For the actual test configuration, please refer to the related item – Photographs of the Test Configuration.

14.4 Test Results

Input Power	230 Vac, 50 Hz	Tested by	Thomas Cheng
Environmental conditions	23 °C, 69% RH	Test Date	2021/3/17
Test mode	Mode 1		

Input DC/AC power port

Voltage (Kv)	Test Point	Polarity (+/-)	Observation	Performance Criterion
1	L1	+/-	Note	A
1	L2	+/-	Note	A
1	PE	+/-	Note	A
1	L1-L2-PE	+/-	Note	A

Signal / telecommunication port

Voltage (Kv)	Test Point	Polarity (+/-)	Observation	Performance Criterion
0.5	LAN 1	+/-	Note	A
0.5	PoE LAN 3	+/-	Note	A

Note: The EUT function was correct during the test.

15 Surge Immunity Test

15.1 Test Specification

Basic Standard:	EN/IEC 61000-4-5
Wave-Shape:	Analogue/digital data ports (direct to outdoor cables*): Port type: unshielded symmetrical 10/700 μ s Open Circuit Voltage 5/320 μ s Short Circuit Current Port type: coaxial or shielded 1.2/50 μ s Open Circuit Voltage 8/20 μ s Short Circuit Current DC network power port (direct to outdoor cables*): 1.2/50 μ s Open Circuit Voltage 8/20 μ s Short Circuit Current AC mains power port: 1.2/50 μ s Open Circuit Voltage 8/20 μ s Short Circuit Current
Test Voltage:	Analogue/digital data ports (direct to outdoor cables): Port type: unshielded symmetrical** w/o primary protectors (line to ground): N/A with primary protectors (line to ground): N/A Port type: coaxial or shielded shield to ground: N/A DC network power port: N/A AC mains power ports: Line to line : ± 0.5 kV, ± 1 kV Line to ground : ± 0.5 kV, ± 1 kV, ± 2 kV
AC Phase Angle (degree):	90° / 270°
Pulse Repetition Rate:	1 time / 20 sec.
Number of Tests:	5 positive and 5 negative at selected points

* This test is only applicable only to ports, which according to the manufacturer's specification, may connect directly to outdoor cables.

** For ports where primary protection is intended, surges are applied at voltages up to 4 kV with the primary protectors. Otherwise the 1 kV test level is applied without primary protection in place.

15.2 Test Instruments

Description & Manufacturer	Model No.	Serial No.	Cal. Date	Cal. Due
TESEQ, Surge Simulator	NSG 3060	1572	May 12, 2020	May 11, 2021
TESEQ, CDN	CDN 3083-100	1215	May 12, 2020	May 11, 2021
Coupling Decoupling Network	CDN-UTP8	045	Aug. 18, 2020	Aug. 17, 2021
TESEQ Coupling Decoupling Network	CDN HSS-2	41009	May 12, 2020	May 11, 2021
TESEQ Coupling Decoupling Network	CDN 118-T8	40386	Sep. 8, 2020	Sep. 7, 2021
TESEQ CDN for Unshielded Unsymmetrical Signal & Data Lines	CDN117	40144	Sep. 8, 2020	Sep. 7, 2021

- Note:
1. The calibration interval of the above test instruments is 12 months and the calibrations are traceable to NML/ROC and NIST/USA.
 2. The test was performed in EMS Room No. 2.
 3. Tested Date: Mar. 29, 2021

15.3 Test Arrangement

a. EUT Power ports:

The surge shall be applied to the EUT power supply terminals via the capacitive coupling network. Decoupling networks are required in order to avoid possible adverse effects on equipment not under test that may be powered by the same lines and to provide sufficient decoupling impedance to the surge wave. The power cord between the EUT and the coupling network shall not exceed 2 meters in length.

For double-insulated products without PE or external earth connections, the test shall be done in a similar way as for grounded products but without adding any additional external grounded connections. If there are no other possible connections to earth, line-to-ground tests may be omitted.

b. Analogue/digital data ports:

- Unshielded unsymmetrical interconnection lines:

The coupling / decoupling networks shall not influence the specified functional conditions of the EUT. The interconnection line between the EUT and the coupling network shall not exceed 2 meters in length.

- Unshielded symmetrical interconnection lines:

For symmetrical interconnection lines and high-speed interconnection lines, the CDN shall be selected to match the number of lines/pairs existing in the cable. If coupling arrestors are used, test levels below the ignition point of the coupling arrestor cannot be specified.

The interconnection line between the EUT and the coupling/decoupling networks shall not exceed 2 meters in length.

In order to avoid the coupling and decoupling capacitors having a filtering effect on the data transfer, a balanced high frequency design associating the coupling capacitors with coupling chokes is required. Where normal functioning of high speed communications lines cannot be achieved because of the impact of the CDN on the EUT, product committees should specify appropriate operation or that no surge immunity test is required.

- Shielded lines:

The EUT is isolated from ground and the surge is applied to its metallic enclosure; the termination (or auxiliary equipment) at the port(s) under test is grounded. This test applies to equipment with one or more shielded cables.

The length of the cable between the port(s) under test and the device attached to the other end of the cable shall be:

- 20 m (preferred length) or,
- the shortest length over 10 m, where the manufacturer provides pre-assembled cables used in actual installations.

No test shall be required for cables which according to the manufacturer's specification are ≤ 10 m.

Rules for application of the surge to shielded lines:

- a) Shields grounded at both ends:
- the test shall be carried out.

The test level is applied on shields with a 2Ω generator source impedance and with the $18 \mu\text{F}$ capacitor.

- b) Shields grounded at one end:
- the test shall be carried out according to unshielded unsymmetrical interconnection lines or unshielded symmetrical interconnection lines because the shield does not provide any protection against surges induced by magnetic fields.

For EUTs which do not have metallic enclosures, the surge is applied directly to the shielded cable at the EUT side.

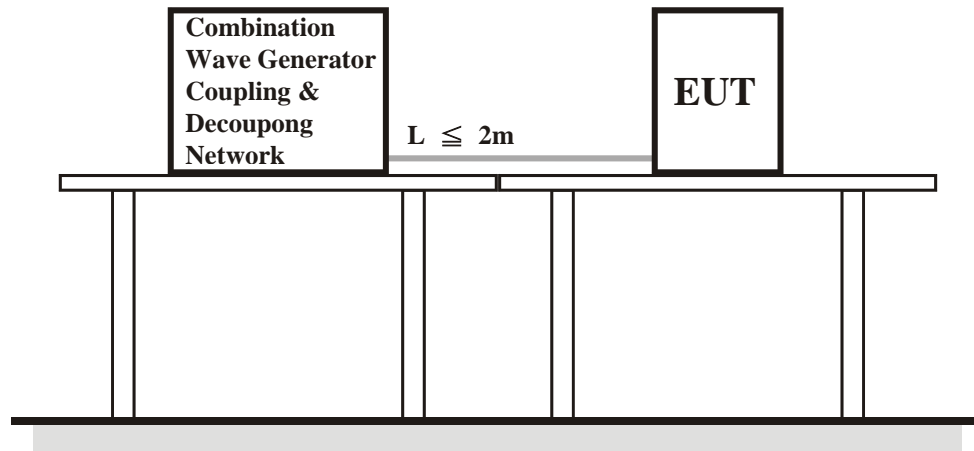

For the actual test configuration, please refer to the related item – Photographs of the Test Configuration.

15.4 Test Results

Input Power	230 Vac, 50 Hz	Tested by	Chiming Li
Environmental conditions	22 °C, 70% RH	Test Date	2021/3/29
Test mode	Mode 1		

Input AC power port

Voltage (kV)	Test Point	Polarity (+/-)	Observation	Performance Criterion
0.5, 1	L1-L2	+/-	Note	A
0.5, 1, 2	L1-PE	+/-	Note	A
0.5, 1, 2	L2-PE	+/-	Note	A

Note: The EUT function was correct during the test.

16 Immunity to Conducted Disturbances Induced by RF Fields (CS)

16.1 Test Specification

Basic Standard:	EN/IEC 61000-4-6
Frequency Range:	0.15 MHz - 80 MHz
Voltage Level:	0.15 MHz - 10 MHz: 3V 10 MHz - 30 MHz: 3-1 V 30 MHz - 80 MHz: 1V
Modulation:	1kHz Sine Wave, 80%, AM Modulation
Frequency Step:	1 % of preceding frequency value
Dwell Time	3 seconds

16.2 Test Instruments

Description & Manufacturer	Model No.	Serial No.	Cal. Date	Cal. Due
ROHDE & SCHWARZ Signal Generator	SML03	101801	Jan. 13, 2021	Jan. 12, 2022
Digital Sweep Function Generator	8120	984801	NA	NA
AR Power Amplifier	75A250AM1	306331	NA	NA
FCC Coupling Decoupling Network	FCC-801-M2-16A	01047	Jun. 18, 2020	Jun. 17, 2021
FISCHER CUSTOM COMMUNICATIONS EM Injection Clamp	F-203I-23mm	455	NA	NA
FISCHER CUSTOM COMMUNICATIONS Current Injection Clamp	F-120-9A	361	Jul. 30, 2020	Jul. 29, 2021
B&K Ear Simulator	4185	2553594	NA	NA
EM TEST Coupling Decoupling Network	CDN M1/32A	306508	Jun. 18, 2020	Jun. 17, 2021
TESEQ Coupling Decoupling Network	CDN T800	34428	Jun. 18, 2020	Jun. 17, 2021
TESEQ Coupling Decoupling Network	CDN T800	29459	Jun. 18, 2020	Jun. 17, 2021
TESEQ Coupling Decoupling Network	CDN T8-230	56641	Feb. 25, 2021	Feb. 24, 2022
TESEQ Coupling Decoupling Network	CDN T8-230	56642	Feb. 25, 2021	Feb. 24, 2022
R&S Power Sensor	NRV-Z5	837878/039	Nov. 10, 2020	Nov. 9, 2021
R&S Power Meter	NRVD	837794/040	Nov. 10, 2020	Nov. 9, 2021
TESEQ Coupling Decoupling Network	CDN M232	37702	Jun. 18, 2020	Jun. 17, 2021
TESEQ Coupling Decoupling Network	CDN M332	41258	Jun. 18, 2020	Jun. 17, 2021
TESEQ Coupling Decoupling Network	CDN M332	41256	Jun. 18, 2020	Jun. 17, 2021
TESEQ Coupling Decoupling Network	CDN T8-10	40376	Jun. 18, 2020	Jun. 17, 2021
TESEQ Coupling Decoupling Network	CDN T8-230	56643	Feb. 25, 2021	Feb. 24, 2022
TESEQ Coupling Decoupling Network	CDN S200	53490	May 27, 2020	May 26, 2021
TESEQ Coupling Decoupling Network	CDN S400	52115	Jun. 18, 2020	Jun. 17, 2021
TESEQ Coupling Decoupling Network	CDN T400A	49918	Feb. 25, 2021	Feb. 24, 2022
FCC Coupling Decoupling Network	FCC-801-M5-50A	100018	Jan. 19, 2021	Jan. 18, 2022
TESEQ Coupling Decoupling Network	CDN T2A-10	54942	Feb. 25, 2021	Feb. 24, 2022
TESEQ Coupling Decoupling Network	CDN S751A	56435	Feb. 25, 2021	Feb. 24, 2022
TESEQ Coupling Decoupling Network	CDN ST08A	56527	Feb. 25, 2021	Feb. 24, 2022
TESEQ Coupling Decoupling Network	CDN ST08A	56525	Feb. 25, 2021	Feb. 24, 2022
TESEQ Coupling Decoupling Network	CDN M432S	56519	Feb. 25, 2021	Feb. 24, 2022
TESEQ Coupling Decoupling Network	CDN S751A	56436	Feb. 25, 2021	Feb. 24, 2022
Software	CS_V7.4.2	NA	NA	NA
Microphone (Ear Simulator)	4192	3073928	Aug. 26, 2020	Aug. 25, 2021
Conditioning Amplifier	2690-0S2	3001996	Nov. 25, 2020	Nov. 24, 2021
B&K Ear Simulator	4185	2553594	NA	NA
ROHDE & SCHWARZ AUDIO ANALYZER	UPV	104565	May 26, 2020	May 25, 2021
Software	ABMS_V7.4.3	NA	NA	NA

Note: 1. The calibration interval of the above test instruments is 12 months and the calibrations are traceable to NML/ROC and NIST/USA.
 2. The test was performed in CS Room No. 1.
 3. Tested Date: Mar. 26, 2021

16.3 Test Arrangement

- The EUT shall be tested within its intended operating and climatic conditions.
- An artificial hand was placed on the hand-held accessory and connected to the ground reference plane.
- One of the CDNs not used for injection was terminated with 50 ohm, providing only one return path. All other CDNs were coupled as decoupling networks.
- The frequency range is swept from 150 kHz to 80 MHz, using the signal level established during the setting process and with a disturbance signal of 80 % amplitude. The signal is modulated with a 1 kHz sine wave, pausing to adjust the RF signal level or the switch coupling devices as necessary. Where the frequency is swept incrementally, the step size shall not exceed 1 % of the preceding frequency value.
- Attempts should be made to fully exercise the EUT during testing, and to fully interrogate all exercise modes selected for susceptibility.

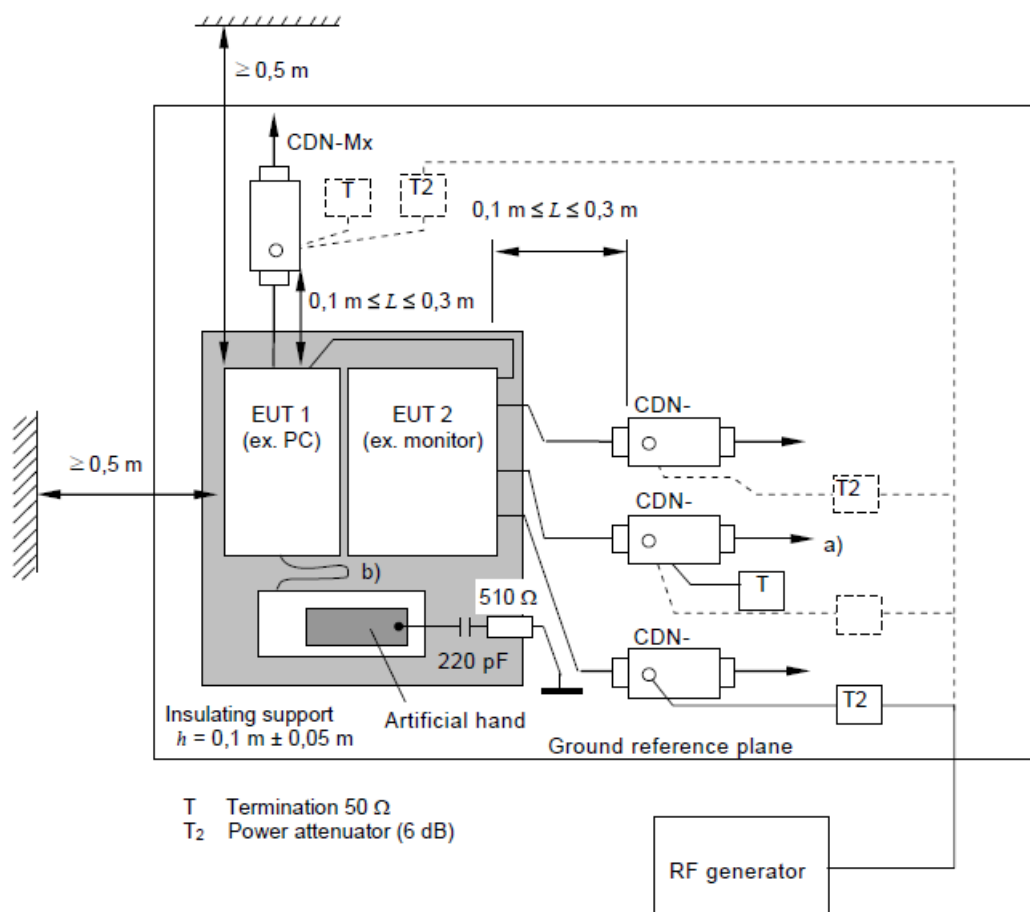

- Note:**
- The EUT clearance from any metallic obstacles shall be at least 0,5 m.
 - Interconnecting cables (≤ 1 m) belonging to the EUT shall remain on the insulating support.
 - The equipment to be tested is placed on an insulating support of 0.1 meters height above a ground reference plane. All relevant cables shall be provided with the appropriate coupling and decoupling devices at a distance between 0.1 meters and 0.3 meters from the projected geometry of the EUT on the ground reference plane.

For the actual test configuration, please refer to the related item – Photographs of the Test Configuration.

16.4 Test Results

Input Power	230 Vac, 50 Hz	Tested by	Chiming Li
Environmental conditions	23 °C, 72% RH	Test Date	2021/3/26
Test mode	Mode 1		

Frequency (MHz)	Level (Vrms)	Tested Line	Injection Method	Return Path	Observation	Performance Criterion	Remark
0.15 – 10	3	AC Power	CDN-M3	CDN-M1	Note	A	-
10 – 30	3 – 1	AC Power	CDN-M3	CDN-M1	Note	A	
30 – 80	1	AC Power	CDN-M3	CDN-M1	Note	A	
0.15 – 10	3	LAN 1	CDN-T8	CDN-M1	Note	A	
10 – 30	3 – 1	LAN 1	CDN-T8	CDN-M1	Note	A	
30 – 80	1	LAN 1	CDN-T8	CDN-M1	Note	A	
0.15 – 10	3	PoE LAN 3	CDN-T8	CDN-M1	Note	A	
10 – 30	3 – 1	PoE LAN 3	CDN-T8	CDN-M1	Note	A	
30 – 80	1	PoE LAN 3	CDN-T8	CDN-M1	Note	A	
0.15 – 10	3	AC Power	CDN-M3	CDN-M1	Note	A	Audio output function
10 – 30	3 – 1	AC Power	CDN-M3	CDN-M1	Note	A	
30 – 80	1	AC Power	CDN-M3	CDN-M1	Note	A	
0.15 – 10	3	LAN 1	CDN-T8	CDN-M1	Note	A	
10 – 30	3 – 1	LAN 1	CDN-T8	CDN-M1	Note	A	
30 – 80	1	LAN 1	CDN-T8	CDN-M1	Note	A	
0.15 – 10	3	PoE LAN 3	CDN-T8	CDN-M1	Note	A	
10 – 30	3 – 1	PoE LAN 3	CDN-T8	CDN-M1	Note	A	
30 – 80	1	PoE LAN 3	CDN-T8	CDN-M1	Note	A	

Note: The EUT function was correct during the test.

Remark: Audio out function (Audio out) electrical reference level pass.

17 Power Frequency Magnetic Field Immunity Test

17.1 Test Specification

Basic Standard:	EN/IEC 61000-4-8
Frequency Range:	50Hz
Field Strength:	1 A/m
Observation Time:	1 minute
Inductance Coil:	Rectangular type, 1 m x 1 m

17.2 Test Instruments

Description & Manufacturer	Model No.	Serial No.	Cal. Date	Cal. Due
HAEFELY Magnetic Field Tester	MAG 100	083794-06	NA	NA
COMBINOVA Magnetic Field Meter	MFM10	224	May 7, 2020	May 6, 2021

- Note:
1. The calibration interval of the above test instruments is 12 months and the calibrations are traceable to NML/ROC and NIST/USA.
 2. The test was performed in EMS Room No. 1
 3. Tested Date: Mar. 29, 2021

17.3 Test Arrangement

- a. The equipment is configured and connected to satisfy its functional requirements.
- b. The power supply, input and output circuits shall be connected to the sources of power supply, control and signal.
- c. The cables supplied or recommended by the equipment manufacturer shall be used. 1 meter of all cables used shall be exposed to the magnetic field.

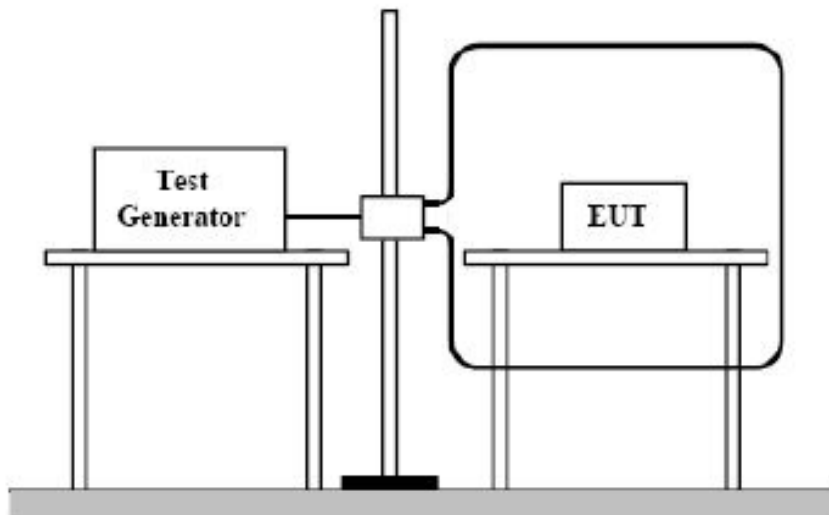

TABLETOP EQUIPMENT

The equipment shall be subjected to the test magnetic field by using the induction coil of standard dimension (1 m x 1 m). The induction coil shall then be rotated by 90 degrees in order to expose the EUT to the test field with different orientations.

For the actual test configuration, please refer to the related item – Photographs of the Test Configuration.

17.4 Test Results

Input Power	230 Vac, 50 Hz	Tested by	Josh Lin
Environmental conditions	22 °C, 77% RH	Test Date	2021/3/29
Test mode	Mode 1		

Application	Frequency (Hz)	Field Strength (A/m)	Observation	Performance Criterion
X - Axis	50	1	Note	A
Y - Axis	50	1	Note	A
Z - Axis	50	1	Note	A

Note: The EUT function was correct during the test.

18 Voltage Dips and Interruptions

18.1 Test Specification

Basic Standard:	EN/IEC 61000-4-11
Test levels:	Voltage Dips: <5% residual – 0.5 cycle, 70% residual – 25 cycles Voltage Interruptions: <5% residual – 250 cycles
Interval between Event:	Minimum ten seconds
Sync Angle (degrees):	0° & 180°
Test Cycle:	3 times

18.2 Test Instruments

Description & Manufacturer	Model No.	Serial No.	Cal. Date	Cal. Due
Teseq Immunity Test System	Proflin 2105	1632A00983 & 1639A01863	Jun. 9, 2020	Jun. 8, 2021
Software	WIN2120	NA	NA	NA

- Note:
1. The calibration interval of the above test instruments is 12 months and the calibrations are traceable to NML/ROC and NIST/USA.
 2. The test was performed in EMS Room No. 1.
 3. Tested Date: Mar. 26, 2021

18.3 Test Arrangement

The EUT shall be tested for each selected combination of test levels and duration with a sequence of 3 dips/interruptions with intervals of 10 s minimum (between each test event). Each representative mode of operation shall be tested. Abrupt changes in supply voltage shall occur at 0 degree crossover point of the voltage waveform.

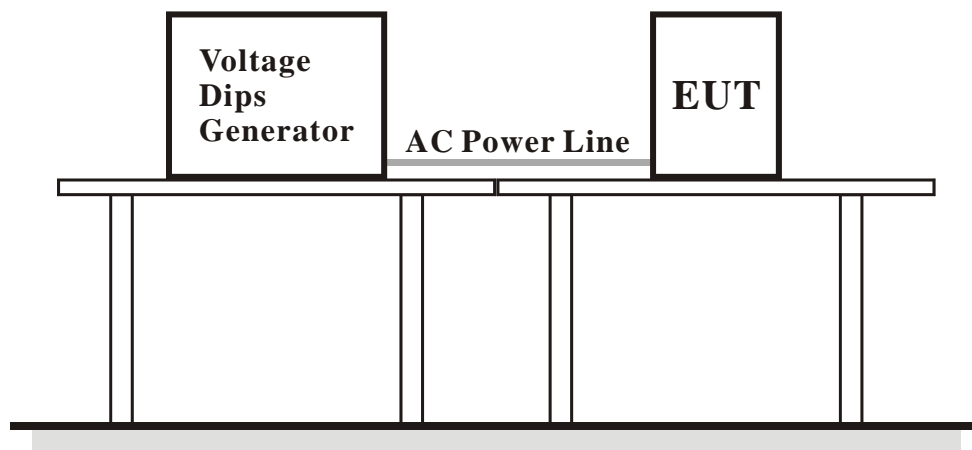

For the actual test configuration, please refer to the related item – Photographs of the Test Configuration.

18.4 Test Results

Input Power	230 Vac, 50 Hz/ 240 Vac, 50 Hz/ 100 Vac, 50 Hz	Tested by	Chiming Li
Environmental conditions	21 °C, 74% RH	Test Date	2021/3/26
Test mode	Mode 1		

Input Power for testing: 230 Vac, 50 Hz (Nominal input Voltage)					
Voltage Residual (%)	Duration (cycle)	Interval (sec)	Times	Observation	Performance Criterion
< 5	0.5	10	3	Note 1	A
70	25	10	3	Note 1	A
< 5	250	10	3	Note 2	C

Input Power for testing: 240 Vac, 50 Hz (Maximum rated input voltage)					
Voltage Residual (%)	Duration (cycle)	Interval (sec)	Times	Observation	Performance Criterion
< 5	0.5	10	3	Note 1	A
70	25	10	3	Note 1	A
< 5	250	10	3	Note 2	C

Input Power for testing: 100 Vac, 50 Hz (Minimum rated input voltage)					
Voltage Residual (%)	Duration (cycle)	Interval (sec)	Times	Observation	Performance Criterion
< 5	0.5	10	3	Note 1	A
70	25	10	3	Note 1	A
< 5	250	10	3	Note 2	C

- Note: 1. The EUT function was correct during the test.
 2. The EUT power off during the test, and must be recovered manually.

19 Pictures of Test Arrangements

19.1 Conducted Emission from the AC Mains Power Port



19.2 Asymmetric Mode Conducted Emission at Telecommunication Ports



19.3 Radiated Emission at Frequencies up to 1GHz



19.4 Radiated Emission at Frequencies above 1GHz

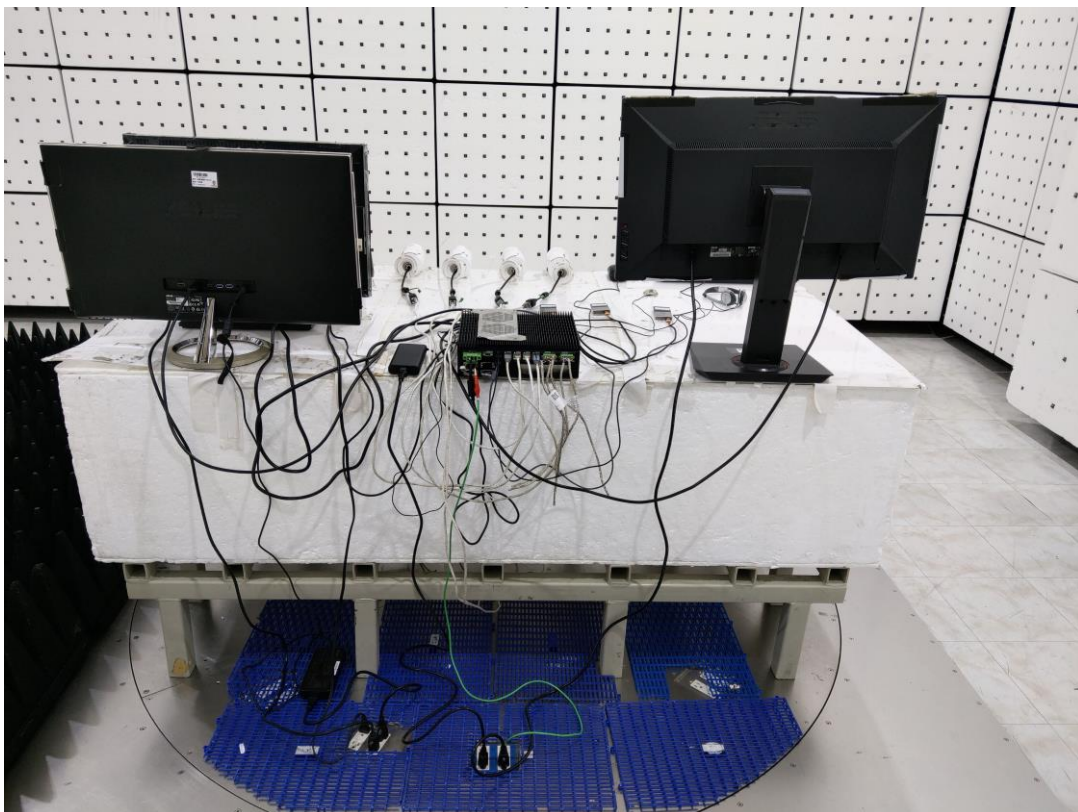

19.5 Harmonics Current, Voltage Fluctuations and Flicker Measurement



19.6 Electrostatic Discharge Immunity Test (ESD)

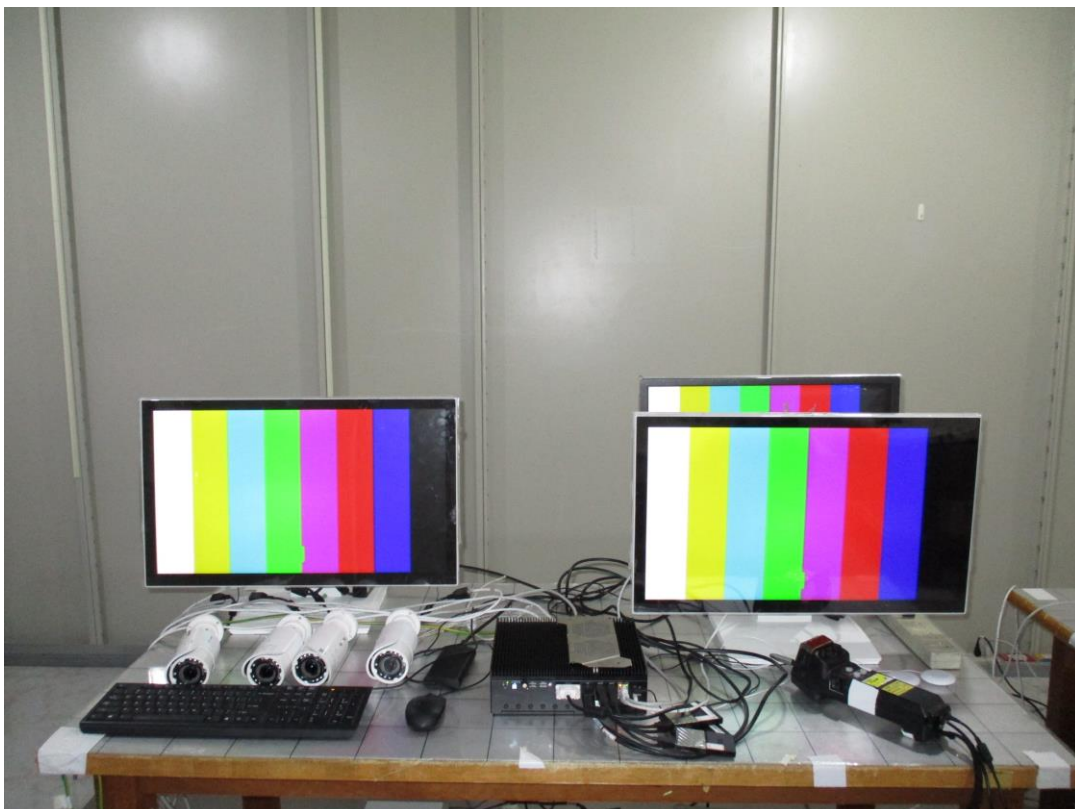

19.7 Radio-frequency, Electromagnetic Field Immunity Test (RS)

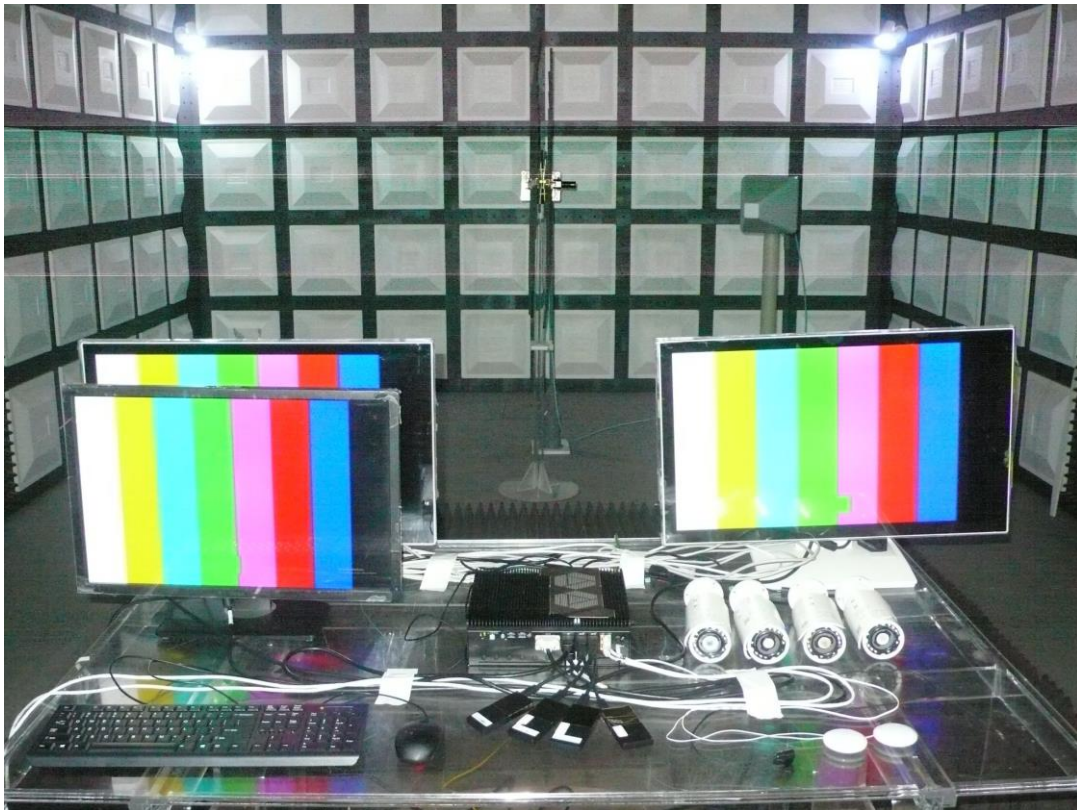

19.8 Electrical Fast Transient/Burst Immunity Test (EFT)

Mains port

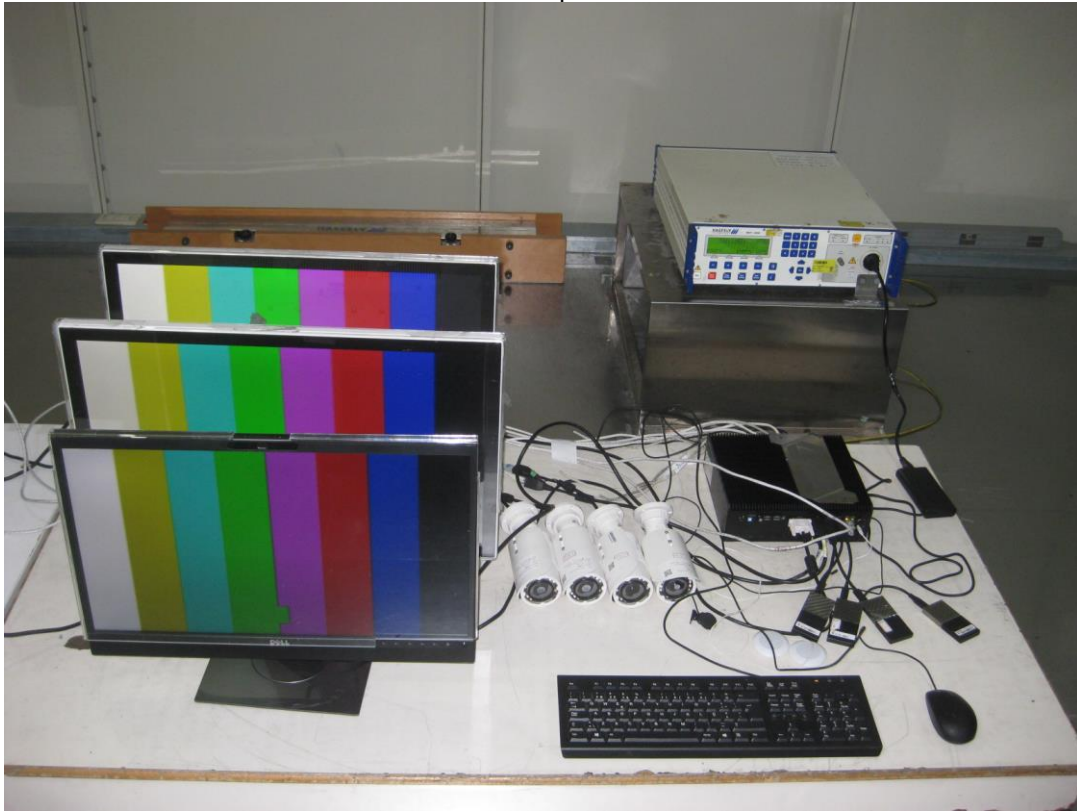

LAN



PoE LAN



19.9 Surge Immunity Test

Mains port



19.10 Conducted Disturbances Induced by RF Fields (CS)

Mains port

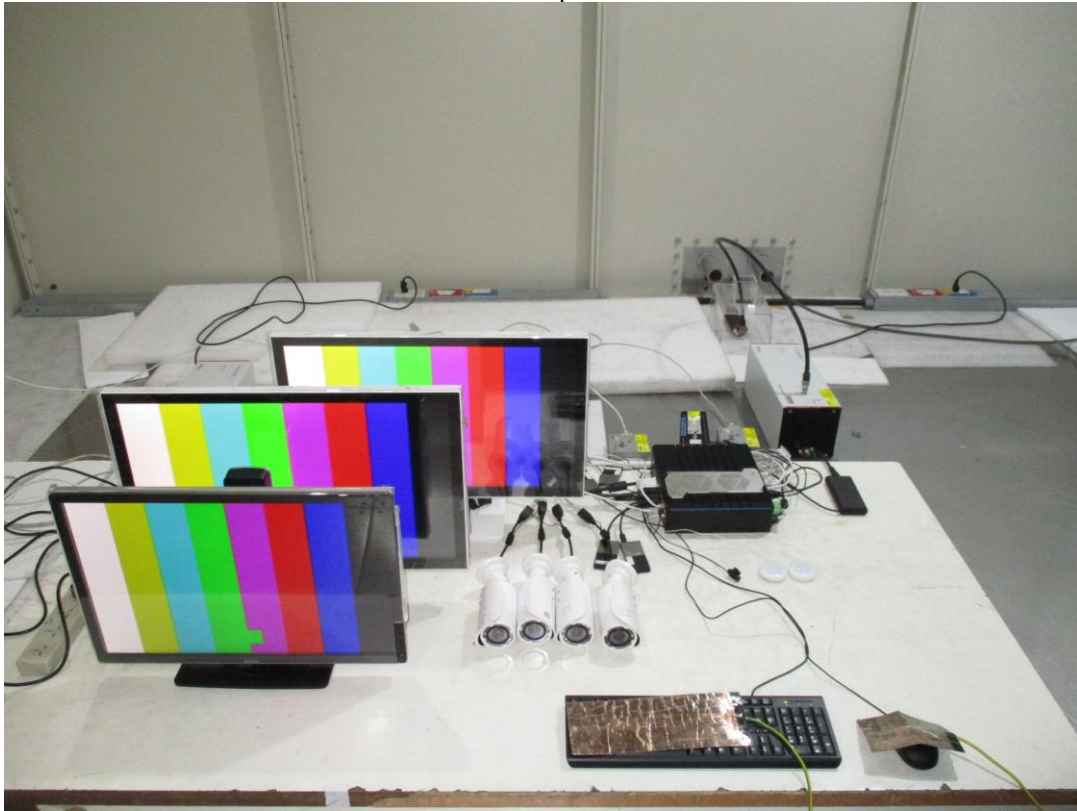

LAN

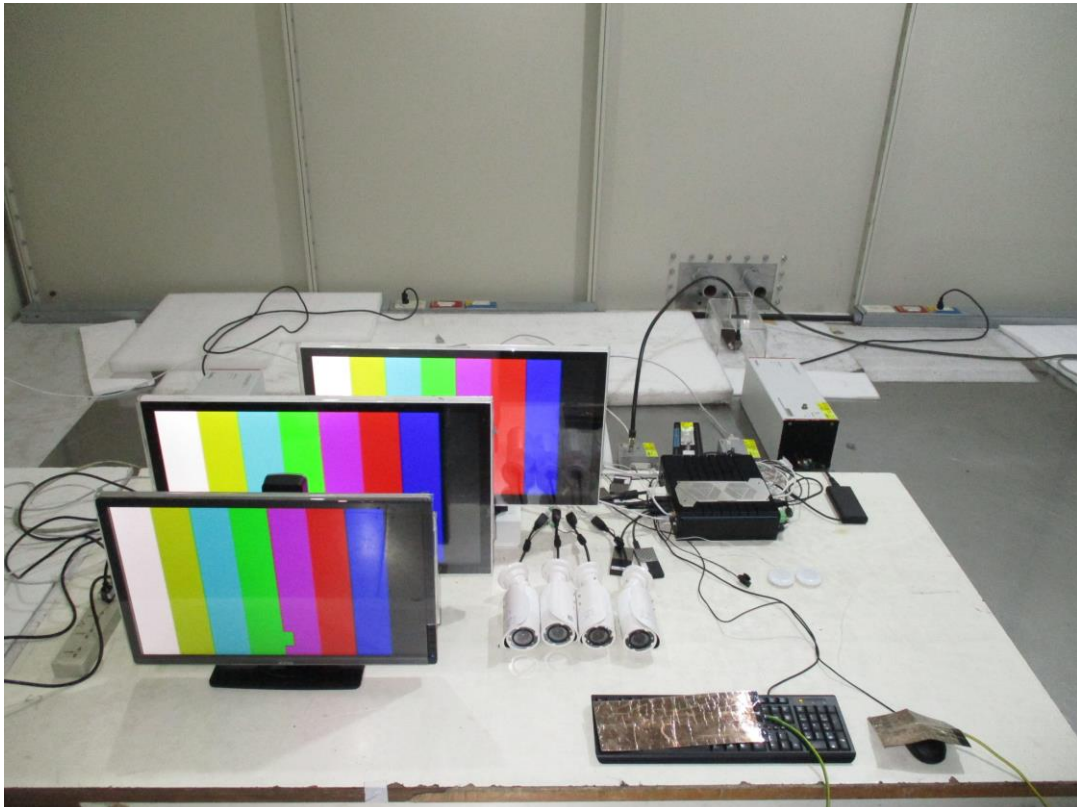

PoE LAN

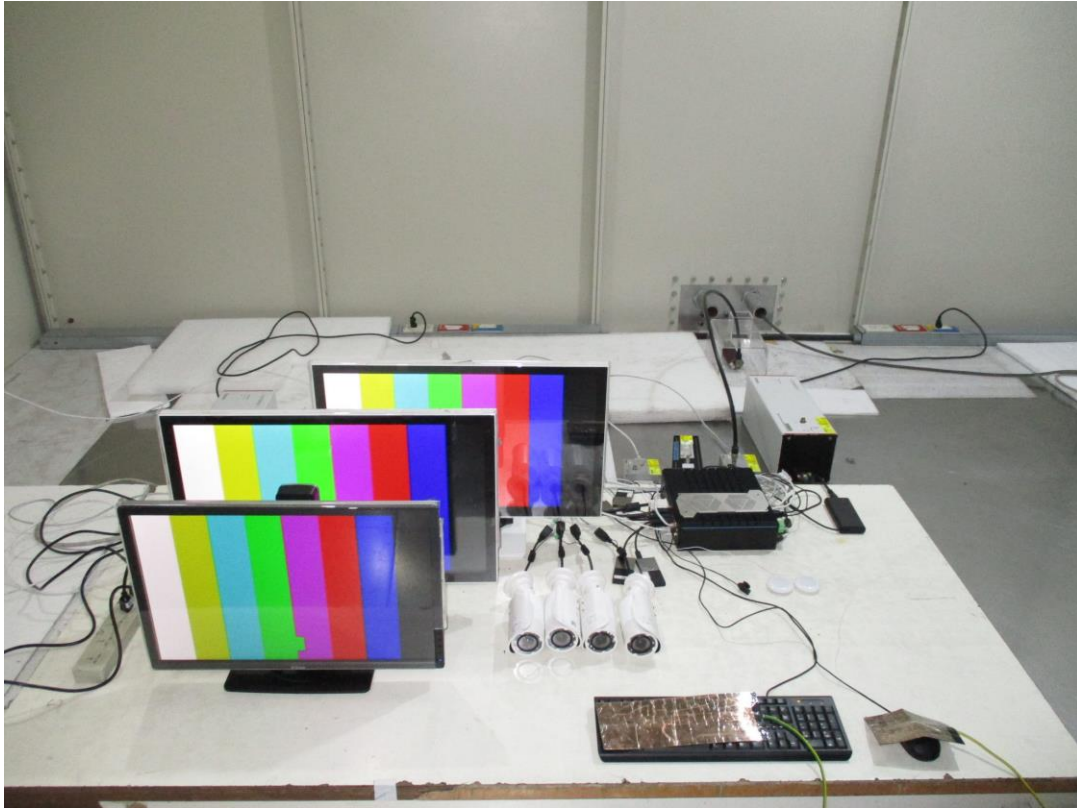

19.11 Power Frequency Magnetic Field Immunity Test (PFMF)



19.12 Voltage Dips and Interruptions



Appendix – Information of the Testing Laboratories

We, Bureau Veritas Consumer Products Services (H.K.) Ltd., Taoyuan Branch, were founded in 1988 to provide our best service in EMC, Radio, Telecom and Safety consultation. Our laboratories are accredited and approved according to ISO/IEC 17025.

If you have any comments, please feel free to contact us at the following:

Lin Kou EMC/RF Lab

Tel: 886-2-26052180

Fax: 886-2-26051924

Hsin Chu EMC/RF/Telecom Lab

Tel: 886-3-6668565

Fax: 886-3-6668323

Hwa Ya EMC/RF/Safety Lab

Tel: 886-3-3183232

Fax: 886-3-3270892

Email: service.adt@tw.bureauVeritas.com

Web Site: www.bureauVeritas-adt.com

The address and road map of all our labs can be found in our web site also.

--- END ---